



User Manual

Pluto0002XW

Digital Wireless Intraoral X-Ray Sensor



E

Ver.: A01  
Doc. ID: 179-201-02  
Date: 06/01/2022

IMAGING THE FUTURE



## To Customers

Thank you for choosing the Pluto0002XW Digital Wireless Intraoral X-Ray Sensor (hereinafter referred to as Pluto0002XW) from iRay Technology Co., Ltd. (hereinafter referred to as iRay Technology) as your X-ray imaging solution.

This user manual describes how to install, use and maintain this product, how to integrate this product into your system, and how to operate the iDetector provided with the Pluto0002XW.

The illustrations in this manual are for explanatory and demonstration purposes only. Actual product may vary due to product enhancement.

Please read this manual thoroughly before using the product and retain it for future reference.

## Copyright

© iRay Technology Co., Ltd. All rights reserved.

Under copyright laws, no part of this publication may be reproduced in any form or by any means without the written permission of iRay Technology Co., Ltd.

## Trademarks



The name “iRay” and iRay logo are registered trademarks of iRay Technology Co., Ltd.

## Caring for the Environment



### ■ Product Disposal

This symbol indicates that this product and its internal battery should not be disposed of with your domestic or commercial waste. Disposal of this product in an unlawful manner may have a negative impact on health and the environment.

When disposing of the product, be sure to follow the procedure that conforms to the laws and regulations in your area. Please note that the built-in battery must be removed and disposed of by a qualified professional.

### ■ Disposal of Biomedical Waste

Dispose of sheaths and other medical waste following the normal dental office procedure for biomedical waste. Improper disposal of those can lead to the spread of illness and disease.

## For Your Safety





- To prevent personal injury or product damage, be sure to read the user manual, familiarize yourself with all accompanying documents carefully and pay attention to all safety precautions before installing and operating the product. Follow exactly the guidelines described in this manual when installing and using this product.
- The installation, debugging, addition, modification, and maintenance of this product can only be carried out by qualified professionals.
- Only qualified and authorized personnel can operate this product.
- The device must be stored and operated in a specified environment and maintained by professional maintenance personnel under safe and operable conditions.
- Use only computers and image display monitors recommended in this manual.
- For details on product installation and use, please consult your sales representative and local dealer.

## Disclaimer

- In no event shall iRay be reliable for any abnormality, product damage, and personal injury caused when the instructions of this manual are not followed.
- In no event shall iRay be reliable for any damage, loss, or injury arising from fire, earthquake, any action or accident by a third party, any intentional or negligent action by users, any trial usage, or other usages under abnormal conditions.
- In no event shall iRay be reliable for any damage, loss, or injury arising from moving, alteration, inspection, or repair of the product by a person other than an authorized service engineer by iRay.
- In no event shall iRay be reliable for any damage or loss arising from the use of any options or consumable products other than those dedicated as original iRay products.
- Roentgenography, image acquiring, image processing, image reading, and image data storage must be performed in accordance with the law of the country where the product is being used.
- In no event shall iRay be reliable for loss of image data for any reason while using the product. The user and operator are responsible for maintaining the privacy of image data acquired from the product.
- Dentists assume the responsibility for the faulty diagnosis, for which iRay bears no liability.
- Due to updates and constantly improving performance, the design and specifications of the device and the contents of this manual are subject to change without prior notice.

## Symbols

The symbols used throughout this manual are classified as follows for better comprehension of their meanings. Take special care to heed all warning symbols inside this manual and obey the instructions they contain.

 WARNING	Denotes a potentially hazardous situation that, if not avoided, will result in severe injury, death, or substantial product damage
 CAUTION	Denotes a potentially hazardous situation that, if not avoided, could result in minor or moderate injury or product damage
 PROHIBITED	Denotes that you should NEVER perform the indicated action.
 NOTE	Indicates supplement important information or advice that helps you make better use of your device
 REFERENCE	Denotes “refer to the documents attached to the CD” or “refer to other Sections of this manual for information”

## Abbreviations

Abbreviation	Explanation
AC	Alternating Current
AED	Automatic Exposure Detection
AP	Access Point
CMOS	Complementary Metal-Oxide-Semiconductor Transistor
DC	Direct Current
DQE	Detective Quantum Efficiency
DR	Digital Radiography
EMC	Electro Magnetic Compatibility
EMI	Electromagnetic Interference
FTP	File Transfer Protocol
IP	Internet Protocol
ISO	International Standardization Organization
IT	Information Technology
LAN	Local Area Network
LED	Light Emitting Diode
MTF	Modulation Transfer Function
PC	Personal Computer
ROI	Range of Interest
RF	Radio Frequency
SAR	Specific Absorption Rate
SDK	Software Development Kit
SID	Source Image Distance

---

Abbreviation	Explanation
SN	Serial Number
SNR	Signal to Noise Ratio
UDI	Unique Device Identification
UI	User Interface
UPS	Uninterrupted Power Supply
WL	Window Level
WLAN	Wireless Local Area Networks
WW	Window Width

---

## Table of Contents

<b>CHAPTER 1</b>	<b>SAFETY PRECAUTIONS .....</b>	<b>1</b>
1.1	Operation and Storage Environment .....	1
1.2	Device, Interface, Battery, and Cable .....	2
1.3	Handling of Device Failures and Serious Incidents .....	3
1.4	Inspection, Cleaning, and Disinfection .....	3
<b>CHAPTER 2</b>	<b>REGULATORY INFORMATION .....</b>	<b>5</b>
2.1	Symbols .....	5
2.2	Safety Standards for Medical Device .....	6
2.2.1	Medical Device Classification .....	6
2.2.2	Safety Standards Reference .....	6
2.3	Guidance and Manufacturer's Declaration for EMC .....	7
2.3.1	Important Information Regarding Electromagnetic Compatibility (EMC) .....	7
2.3.2	EMI Compliance Table .....	7
2.3.3	EMS Compliance Table .....	8
2.3.4	Cable Information Provided Against EMC .....	9
2.4	Radio Frequency (RF) Compliance Information .....	10
2.5	Radio Frequency (RF) Energy .....	11
2.6	FCC Compliance .....	11
<b>CHAPTER 3</b>	<b>ABOUT THE PRODUCT .....</b>	<b>12</b>
3.1	Overview .....	12
3.2	Packaging Contents .....	12
3.3	Product Description .....	14
3.3.1	Sensor .....	14
3.3.2	Charging Base .....	15
<b>CHAPTER 4</b>	<b>TECHNICAL SPECIFICATIONS .....</b>	<b>16</b>
4.1	Pluto0002XW .....	16
4.2	Power Adapter .....	17
4.3	Workstation (Recommended but not Included) .....	18

4.4	Router (Recommended but not Included).....	18
4.5	Wireless Communication.....	19
4.6	IT Network.....	19
<b>CHAPTER 5 USE.....</b>		<b>21</b>
5.1	Installing and Removing the AC Plug.....	21
5.2	Charging the System.....	21
5.3	Switching ON/OFF the System.....	22
5.4	Wireless Connection.....	22
5.4.1	AP Mode.....	22
5.4.2	Client Mode.....	22
5.5	Switching Wireless Mode and Restoring to Factory Settings.....	23
5.6	Installing Disposable Sanitary Sheaths.....	24
5.7	Device Placement.....	24
5.8	Operating Process.....	25
<b>CHAPTER 6 SOFTWARE INSTALLATION AND CONFIGURATION.....</b>		<b>26</b>
6.1	How to Set up an Operating Environment.....	26
6.2	How to Launch the iDetector.....	26
6.3	Communication Configuration.....	26
6.3.1	Configuring the AP Mode.....	26
6.3.2	Configuring the Client Mode.....	28
6.3.3	Modifying the IP Address.....	28
<b>CHAPTER 7 USER INTERFACE.....</b>		<b>30</b>
7.1	Home Page.....	30
7.2	Acquire Page.....	31
7.3	SDK Page.....	33
7.4	Detector Page.....	34
7.5	Calibrate Page.....	36
7.6	Local File Page.....	36
<b>CHAPTER 8 INSTRUCTIONS FOR IDETECTOR.....</b>		<b>38</b>
8.1	Management of Calibration Templates.....	38
8.1.1	Creating Calibration Templates.....	38
8.1.2	Modifying Defect Calibration Template.....	41

---

8.1.3	Checking the Validity of Calibration Template .....	43
8.2	Acquiring and Saving Image .....	43
8.2.1	Loading Calibration Templates .....	43
8.2.2	Saving a Single Image .....	44
8.3	Checking Local Images .....	46
8.4	Firmware Upgrade .....	47
<b>CHAPTER 9 TROUBLESHOOTING .....</b>		<b>48</b>
<b>CHAPTER 10 SERVICE INFORMATION .....</b>		<b>50</b>
10.1	Product Life .....	50
10.2	Regular Inspection .....	50
10.2.1	Daily Inspection .....	50
10.2.2	Monthly or Yearly Inspection .....	51
10.3	Maintenance .....	51
10.4	Cleaning and Disinfection .....	52
10.5	After-Sales Service .....	53



## Chapter 1 Safety Precautions

---

This chapter provides safety precautions that you need to know to ensure the safe use of the device.



WARNING

Install and operate this device in accordance with all safety laws and regulations applicable to the installation of medical devices in your local area and the instructions in this manual to avoid device damage and personal injury caused by improper installation and operation.

### 1.1 Operation and Storage Environment

---

- **Do not store or operate the system in any of the locations listed below. Ignoring this warning may result in device falling, device malfunction, explosion, fire, or personal injury.**

- 1) Close to facilities where water is used
- 2) Where it will be exposed to direct sunlight
- 3) Close to the air outlet of an air-conditioner or ventilation device
- 4) Close to a heat source such as a heater
- 5) Where the power supply is unstable
- 6) In a location exposed to strong magnetic fields
- 7) In an oxygen-rich environment
- 8) Where there is flammable, explosive, corrosive gas, liquid, or other substances
- 9) In a dusty environment
- 10) In a saline or sulfurous environment
- 11) Where temperature or humidity is higher than the specified operating/storage environment
- 12) In an environment prone to freezing or condensation
- 13) In an area prone to vibration
- 14) On an incline or in an unstable area
- 15) In an area with altitude over 3000 meters



WARNING

- **The device must be used only in rooms or areas which comply with all laws and regulations for electrical safety in medical premises, where provisions for safety ground connections are present.**

- **Operate this device at 10°C~40°C and 20%~90% relative humidity, and store it at -20°C ~55°C and 10%~95%RH.**



CAUTION

If the temperature or humidity changes drastically, condensation may form inside the device, causing internal circuit failure. Air conditioners, heaters or ventilation devices can be used to control indoor temperature and humidity.

- **When condensation is attached to the system, be sure to cut off the power supply and let the device stand for at least 2 hours to make sure it has been acclimated to the temperature and humidity of the environment.**
-

- **Be sure to avoid placing the product in close proximity to other devices which could produce electromagnetic interference (EMI). Even device which meets the national emission standards may still affect the function of the system.**

Otherwise, the imaging performance of the sensor may be degraded, diagnostic information of the X-ray image may be lost, or the patient's radiation dose may be unnecessarily increased.

- **Do not move and store this device together with sharp or metal objects.**

Failure to do so may result in scratches on the surfaces of the device or components, or damage to the interfaces.

## 1.2 Device, Interface, Battery, and Cable

- **Personnel not authorized by iRay Technology are prohibited to open the device enclosure.**

- **No modification of this device is allowed.**

Ignoring this warning may result in an explosion, fire, or electric shock, which may result in personal injury, death, or substantial product damage.

- **Do not connect the sensor to any component or accessory other than iRay's original ones. Do not use any type of power adapter and charging base other than the ones provided with the device.**

Ignoring this warning may result in an explosion, fire, or electric shock, which may result in personal injury, death, or substantial product damage.

- **Do not modify the adapter cable or subject it to external stress or damage. Avoid placing anything heavy on the cable, stepping on the cable, pulling the cable, or subjecting the cable to excessive bending or bundling.**

Ignoring this warning may result in cable failure, which may result in personal injury, death, or product damage.

- **Do not plug or unplug the power plug with wet hands.**

Otherwise, electric shock could occur, resulting in personal injury or even death.

- **Do not hit or drop the device.**

If it is subjected to strong vibration, it may be damaged, and if used without repair, it may cause fire or electric shock.

- **The adapter plug must be firmly inserted into the grounded AC power socket.**

If contact failure occurs, or if metal objects come into contact with the exposed metal prongs of the plug, fire or electric shock may result.

- **Do not place the device with sharp or metal objects. Do not press the charging port on the device and charging base with sharp and metal objects other than the supplied reset device.**

Otherwise, the device or charging base may be damaged.

- **Be sure to disconnect the power cable by holding the plug or connector, not by dragging the cable itself.**

Doing so may result in damage to the cable, leading to fire or electric shock.



WARNING



CAUTION



NOTE

- The device comes partially charged. It is recommended you fully charge it before the first use to ensure its optimal performance and longevity.
- It takes approximately 3 hours to fully charge the device. The specific charging time may be affected by the battery and remaining battery power level.
- If this device will not be used for a long period of time, make sure to charge it to 30%~50% every 3 months and 50%~70% every 6 months to maintain its best performance.
- The battery may have expired if it is consumed quickly after being fully charged. In this case, take the device to the service center authorized by iRay Technology to replace the battery.
- The device and charging base may heat up slightly during charging. This does not affect the device's service life or performance.
- As battery overcharge is prevented by the device, you can always store it on the charging base to maintain it at full power.

### 1.3 Handling of Device Failures and Serious Incidents



CAUTION

- Turn off the sensor, unplug the adapter immediately, and contact your sales representative or local iRay dealer if any of the following occurs:
  - a) When there is smoke, an odd smell, or an abnormal sound
  - b) When the liquid has been spilled into the device and the charging base
  - c) When the device or its components has been dropped and is damaged
  - d) When the device fails and cannot work normally (including acquisition failure, communication failure, etc.)
  - e) When the image quality deteriorates significantly
- Report to the competent authority in your country/region and iRay Technology if any serious incident occurs during and after the use of the device.

### 1.4 Inspection, Cleaning, and Disinfection



WARNING

- Be sure to turn off the power of the system, and unplug the adapter plug from the AC outlet when the inspections indicated in this manual are going to be performed.  
Ignoring this warning may result in an explosion, fire, or unknown hazards.
- Do not immerse the device in liquids. NEVER use flammable cleaning agents (e.g. alcohol, ether) and other corrosive liquids (e.g. methanol, benzene, acid, alkali) to clean the device.
- Do not sterilize the sensor using autoclave or UV oven.
- The sensor must be repaired by iRay's authorized personnel only.  
Ignoring this warning may result in explosion, fire, electric shock, or unknown hazards, which may result in severe personal injury, death, or substantial product damage.



- **Make sure that the system's surface, plug, and port are dry before turning ON the power.**

Otherwise, it may result in fire or electric shock.

- **For safety reasons, be sure to cut off the power supply when it is not in use, and never maintain the product while it is in use.**

- **Clean the plug of the power cord periodically by unplugging it from the AC outlet and remove dust and dirt from the plug, its periphery, and the AC outlet with a dry cloth.**

If the power cord is left plugged in for an extended period in a dusty, dark, and humid environment, the dust around the outlet will absorb moisture, possibly causing insulation failure and fire.











---





## Chapter 2 Regulatory Information

This chapter depicts the labels attached to the package box, the device, and its accessories, and collects some basic regulatory information.

### 2.1 Symbols

All symbols shown below are for description and explanation only.

Symbol	Explanation
	Indicates “Keep the device upright”
	Indicates “Fragile, handle with care”
	Indicates “Keep Dry”
	Indicates the maximum number of stacks
	Indicates the temperature limits to which the product can be safely exposed
	Indicates the humidity limits to which the product can be safely exposed
	Indicates “Keep away from direct sunlight”
	Indicates the manufacturer’s 19-digit serial number as shown below: $A_1A_2A_3A_4B_1B_2C_1C_2L M_1M_2D_1D_2Y_1Y_2X_1X_2X_3X_4$
	<ul style="list-style-type: none"> <li>Production Series No.</li> <li>Production Date</li> <li>Production Site</li> <li>Production Version No.</li> <li>Derivative Type</li> <li>Production Type</li> </ul>
	Indicates the name and address of the manufacturer
	Indicates the name and address of iRay’s authorized representative in the region of the European Union
	Indicates “Caution! Please refer to the instructions in this manual”

Symbol	Explanation
	Represents “please follow operating instructions for use”
	Represents “Attention! Consult this user manual for general information”
	Indicates that the product must be sent to the appropriate facility for recycling when the end user intends to discard the product
	Represents non-ionized electromagnetic radiation
<b>IP44</b>	Indicates the degrees of protection provided by the handle (IP Code) against solid objects or liquids is equivalent to IP44
	Indicates the device contains BF type applied part
<b>MD</b>	Indicates this product is a medical device

## 2.2 Safety Standards for Medical Device

### 2.2.1 Medical Device Classification

Item	Classification
Type of protection against electrical shock	Internally powered device
Degree of protection against electrical shock	Type BF applied part
Degree of protection against ingress of water	IP68 (CMOS sensor) IP44 (handle) IP44 (charging base)
Mode of operation	Continuous operation
Flammable anesthetics	<ul style="list-style-type: none"> <li>Not suitable for use in the presence of a flammable anesthetic mixture with air or with oxygen or nitrous oxide</li> <li>Not suitable for use in the oxygen-rich environment</li> </ul>

### 2.2.2 Safety Standards Reference

The safety standards listed below apply to the product and its accessories.

- Pluto0002XW conforms to this IEC 60601-1-2:2014 standard on both immunity and emissions.
- Use only computers and image display monitors complying with IEC 60601-1 or IEC 60950-1.

Standard	Description
IEC 60601-1:2005/AMD2:2020	Medical electrical equipment - Part 1: General requirements for basic safety and essential performance
IEC 60601-1-2:2014/AMD1:2020	Medical electrical equipment - Part 1-2: General requirements for basic safety and essential performance - Collateral Standard: Electromagnetic disturbances - Requirements and tests
IEC 60601-2-65:2012	Medical electrical equipment - Part 2-65: Particular requirements for the basic safety and essential performance of dental intra-oral X-ray equipment

## 2.3 Guidance and Manufacturer's Declaration for EMC

### 2.3.1 Important Information Regarding Electromagnetic Compatibility (EMC)

Pluto0002XW needs special precautions regarding EMC and needs to be installed only by iRay or authorization engineers and put into service according to the EMC information provided in the user manual.

- This equipment in use may be susceptible to electromagnetic interference from portable and mobile RF communications such as mobile (cellular) telephones. Electromagnetic interference may result in incorrect operation of the system and create a potentially unsafe situation.
- The use of accessories and cables other than those specified by iRay, with the exception of accessories and cables sold by iRay of Pluto0002XW as replacement parts for internal components, may result in increased emissions or decreased immunity of the sensor.
- Pluto0002XW should not be used adjacent to or stacked with other devices. In case adjacent or stacked use is necessary, the sensor should be observed to verify normal operation in the configuration in which it will be used.

### 2.3.2 EMI Compliance Table

#### ■ Electromagnetic Emissions

Emission Test	Compliance	Electromagnetic Environment-Guide
Conducted and radiated RF emissions CISPR 11	Group 1 Class B	
Harmonic distortion IEC 61000-3-2	Class A	Professional healthcare facility environment
Voltage fluctuations/flicker IEC 61000-3-3	Complies	

### 2.3.3 EMS Compliance Table

#### ■ Enclosure Port

Phenomenon	Basic EMC Standard	Immunity Test Levels
		Professional Healthcare Facility Environment
Electrostatic Discharge	IEC 61000-4-2	±8kV contact ±2kV, ±4kV, ±8kV, ±15kV air
Radiated RF EM field	IEC 61000-4-3	3V/m 80MHz-2.7GHz 80% AM at 1kHz
Proximity fields from RF wireless communications equipment	IEC 61000-4-3	Refer to table "Proximity Fields from RF Wireless Communications Equipment"
Rated power frequency magnetic fields	IEC 61000-4-8	30A/m 50Hz or 60Hz

#### ■ Proximity Fields from RF Wireless Communications Equipment

Test frequency (MHz)	Band (MHz)	Immunity Test Levels
		Professional Healthcare Facility Environment
385	380-390	Pulse modulation 18Hz, 27V/m
450	430-470	FM, ±5kHz deviation, 1kHz sine, 28V/m
710		
745	704-787	Pulse modulation 217Hz, 9V/m
780		
810		
870	800-960	Pulse modulation 18Hz, 28V/m
930		
1720		
1845	1700-1990	Pulse modulation 217Hz, 28V/m
1970		
2450	2400-2570	Pulse modulation 217Hz, 28V/m
5240		
5500	5100-5800	Pulse modulation 217Hz, 9V/m
5785		

## ■ Input A. C. Power Port

Phenomenon	Basic EMC Standard	Immunity Test Levels
		Professional Healthcare Facility Environment
Electrical fast transients/burst	IEC 61000-4-4	±2kV 100kHz repetition frequency
Surges Line-to-line	IEC 61000-4-5	±0.5kV, ±1kV
Surges Line-to-ground	IEC 61000-4-5	±0.5kV, ±1kV, ±2kV
Conducted disturbances induced by RF fields	IEC 61000-4-6	3V 0.15MHz - 80MHz 6V in ISM bands between 0.15MHz and 80MHz 80% AM at 1kHz
Voltage dips	IEC 61000-4-11	0% U <sub>T</sub> ; 0.5 cycle At 0°, 45°, 90°, 135°, 180°, 225°, 270° and 315° 0% U <sub>T</sub> ; 1 cycle 70% U <sub>T</sub> ; 25/30 cycles Single phase: at 0°
Voltage interruptions	IEC 61000-4-11	0% U <sub>T</sub> ; 250/300 cycles

## ■ Signal Input/Output Parts Port

Phenomenon	Basic EMC Standard	Immunity Test Levels
		Professional Healthcare Facility Environment
Electrostatic discharge	IEC 61000-4-2	±8kV contact ±2kV, ±4kV, ±8kV, ±15kV air
Electrical fast transients/bursts	IEC 61000-4-4	±1kV 100kHz repetition frequency
Surges Line-to-ground	IEC 61000-4-5	±2kV
Conducted disturbances induced by RF fields	IEC 61000-4-6	3V 0.15MHz - 80MHz 6V in ISM bands between 0.15MHz and 80MHz 80% AM at 1kHz

### 2.3.4 Cable Information Provided Against EMC

Cable	Recommended Length	Shielded/unshielded	Qty.	Classification
DC power cable (adapter)	1m	Unshielded	1	DC power

## 2.4 Radio Frequency (RF) Compliance Information

Nation	Item
U.S.A	47 CFR part 15, subpart B 47 CFR part 15, subpart C 15.247 47 CFR part 15, subpart E 15.407 KDB447498 D01 v06 General Exposure Guidance
European Union	EN 55032: 2015 + A11:2020 EN 55035: 2017 + A11:2020 ETSI EN 301 489-1 V2.2.3 ETSI EN 301 489-3 V2.1.1 ETSI EN 301 489-17 V3.2.4 EN IEC 61000-3-2: 2019 EN 61000-3-3: 2013 ETSI EN300 328 V2.2.2 (2019-07) ETSI EN301 893 V2.1.1 (2017-05) ETSI EN300 440 V2.1.1 (2017-03) EN 50566:2017 EN 62209-2:2010+A1:2019 EN 62479:2010

## 2.5 Radio Frequency (RF) Energy

This device is designed and manufactured not to exceed the emission limits for exposure to radio frequency (RF) energy set by the Federal Communications Commission of the United States.

The exposure standard for wireless devices employing a unit of measurement is known as the Specific Absorption Rate, or SAR. The SAR limit recommended by the general public is 1.6W/kg Averaged over one gram of tissue by IEEE Std 1528.

The FCC has granted an Equipment Authorization for this product with all reported SAR Levels evaluated as in compliance with the FCC RF exposure guidelines. While there may be differences between the SAR levels of various product and at various positions, they all meet the government requirements.

SAR compliance for body-worn operation is based on a separation distance of 0 mm between the unit and the human body. Carry this device at least 0 mm away from your body to ensure RF exposure level compliant or lower to the reported level.

## 2.6 FCC Compliance

FCC ID: 2ACHK-02113698

This device complies with part 15 of the FCC Rules. Operation is subject to the following two conditions:

- This device may not cause harmful interference.
- This device must accept any interference received, including interference that may cause undesired operation.

This equipment has been tested and found to comply with the limits for a Class B digital device, pursuant to part 15 of the FCC Rules. These limits are designed to provide reasonable protection against harmful interference in a residential installation. This equipment generates, uses and can radiate radio frequency energy and, if not installed and used in accordance with the instructions, may cause harmful interference to radio communications. However, there is no guarantee that interference will not occur in a particular installation. If this equipment does cause harmful interference to radio or television reception, which can be determined by turning the equipment off and on, the user is encouraged to try to correct the interference by one or more of the following measures:

- Reorient or relocate the receiving antenna.
- Increase the separation between the equipment and receiver.
- Connect the equipment into an outlet on a circuit different from that to which the receiver is connected.
- Consult the dealer or an experienced radio/ TV technician for help.

Changes or modifications not expressly approved by the manufacturer could void the user's authority to operate the equipment.

## Chapter 3 About the Product

---

This chapter gives an introduction to the device itself, and its packaging contents.

### 3.1 Overview

Pluto0002XW is a portable handheld wireless X-ray intraoral sensor based on complementary metal-oxide semiconductor (CMOS) technology. Using the CsI:Ti scintillator, it is able to provide high-quality dental diagnostic images for diagnosis by X-ray medical systems. Its wireless function allows the operator to efficiently perform dental examinations of patients in any position.

The iDetector can integrate the Pluto0002XW into your DR system, and run on the workstation with Windows operating system for sensor configuration, image acquisition, image preprocessing, and image browsing. iDetector allows you to control the sensor in the absence of a DR system.

#### ■ Intended Use

The Pluto0002XW works with an adapted intraoral dental X-ray machine for static digital intraoral X-ray imaging in healthcare institutions.

The device is intended for use by trained and qualified dentists, dental technicians, and maintenance personnel.

It is not suitable for mammography and dynamic imaging photography. Do not use it on pregnant women.

#### ■ Key Features

- Wireless connection
- Equipped with an advanced CMOS sensor
- Provides low-dose and high-resolution images
- Ergonomically designed
- Lightweight and robust design
- IP68 IP rating
- AED trigger available
- Comes with an SDK, easy to integrate

### 3.2 Packaging Contents

The Pluto0002XW system is carefully inspected and packaged prior to shipment. Upon receipt of the package, be sure to locate each of the system items shown below.

Sensor (Pluto0002XW) ×1

Power adapter (switching power supply) ×1

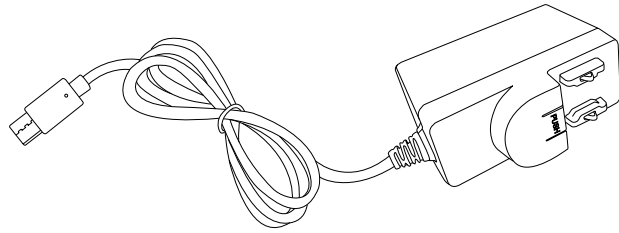

Charging base (Charger-KW) ×1

AC plug (choose 1 pc.) ×1

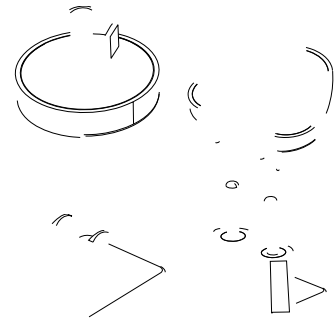

USB×1

Documents×3

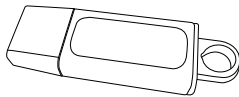

Gain calibration file  
Defect calibration file  
SDK  
Supplied App



OQC Testing Report  
Packing List  
Sensor Certificate of Quality



NOTE

The actual packing list of the Pluto0002XW may vary depending on your customization needs or accessories available in your region. Carefully check if the packaging contents match the packing list, and contact your iRay Technology dealer within 24 hours of receipt if any parts are missing or damaged.

### 3.3 Product Description



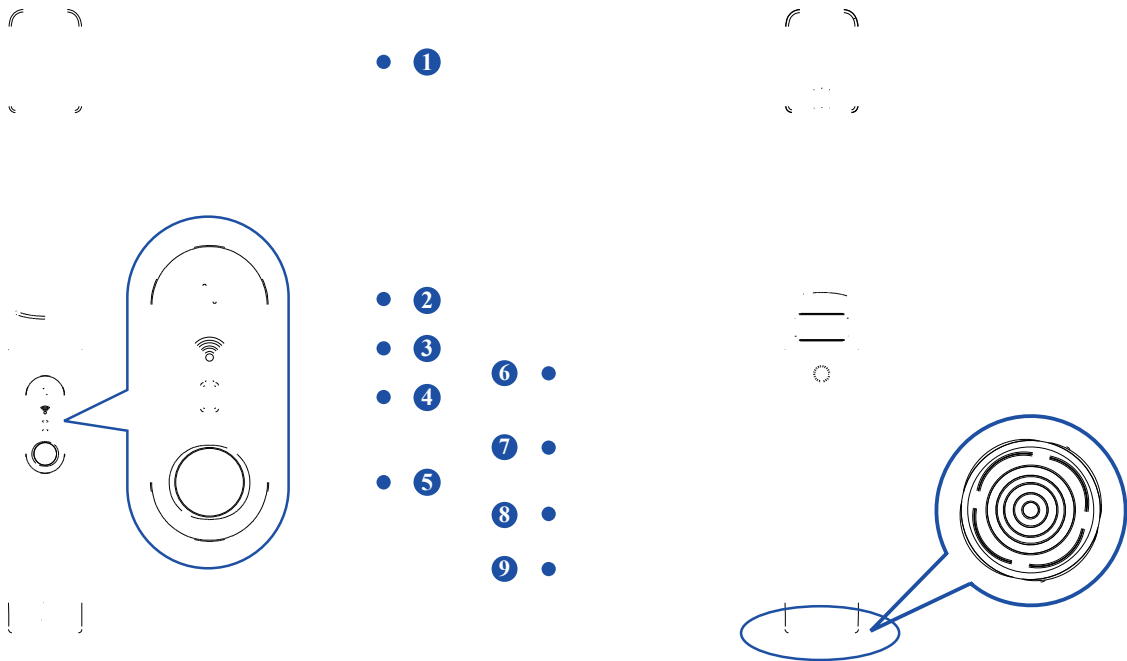

#### 3.3.1 Sensor



No.	Name	No.	Name
①	CMOS sensor	⑥	Near field communication region
②	STATUS indicator	⑦	Handle
③	LINK indicator	⑧	Sensor label
④	POWER indicator	⑨	Charging port
⑤	Power button		

#### ■ LED Indicators

LED	Status	Figure	FPD Status
STATUS indicator	Off		Exposure allowed (in idle state)
	Steady green		Exposure prohibited (data transfer in progress)
LINK indicator	Off		Client mode not built
	Steady blue		AP mode: wireless AP is ready
	Steady green		Client mode: wireless connection is built

LED	Status	Figure	FPD Status
POWER indicator	Operating	Steady orange 	Sufficient power (30%~100%)
		Flashing orange  	Insufficient power (0%~30%)
	Charging	Steady blue 	Charge in progress
		Off 	Fully charged (100%)

### 3.3.2 Charging Base

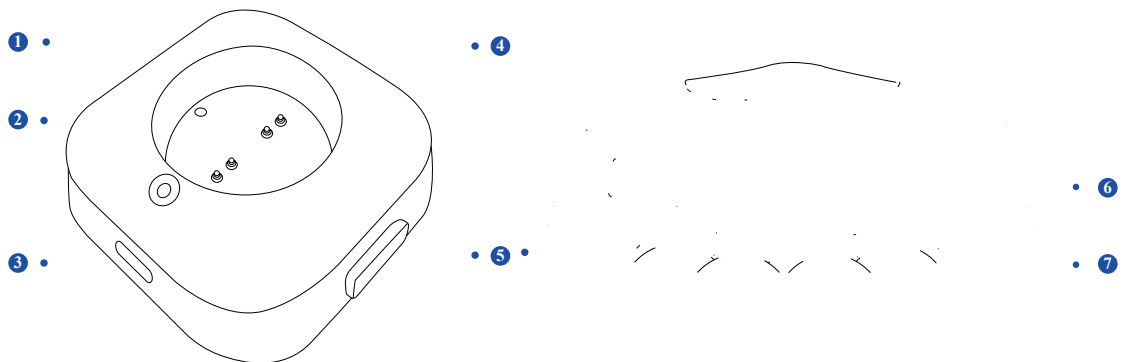

No.	Name	No.	Name
①	Drain hole	⑤	Reset device
②	Charging indicator	⑥	Charging base label
③	Type-C port	⑦	Suction cups
④	Pogo pins		

## Chapter 4 Technical Specifications

This chapter covers the drawings and the technical specifications you may need to better understand this device.



NOTE

Please note that the specifications described below are nominal values that may not exactly match actual values.

### 4.1 Pluto0002XW

#### ■ Drawing

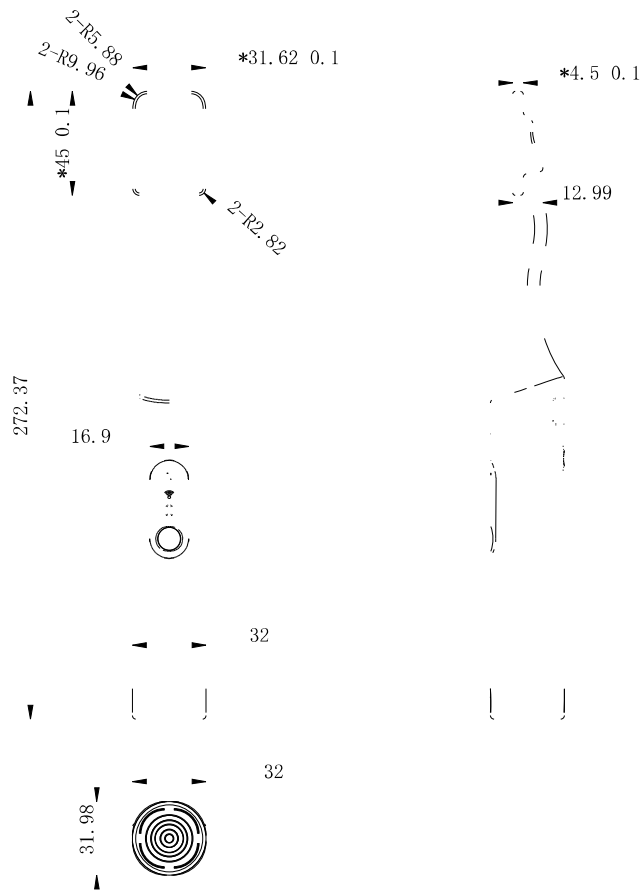

#### ■ Specifications

Item	Specification
Model	Pluto0002XW
Application	Dental intraoral application
Scintillator	CsI: TI

Item	Specification
Image sensor	CMOS
Pixel pitch	20 $\mu$ m
Active area	26mm×36mm
Effective pixel matrix	1300×1800
ADC	16-bit
Trigger mode	AED
AED trigger threshold	<50 $\mu$ Gy/s
Exposure window time	10ms~3s
X-ray energy	55~100kV
Data/config. info transfer	Wireless (2.4G/5.8G Hz)
Max. linear dose	$\geq$ 300uGy
Dynamic range	$\geq$ 50dB
Recommended operating environment conditions	Temperature: 10°C~40°C Humidity: 20%~90%RH Atmospheric pressure: 700~1060 mbar
Recommended storage & transport conditions	Temperature: -20°C~55°C Humidity: 10%~95%RH Atmospheric pressure: 700~1060 mbar
Dimensions	32mm (L)×31mm (W)×272mm (H)
Weight	180g

## 4.2 Power Adapter

### ■ Drawing

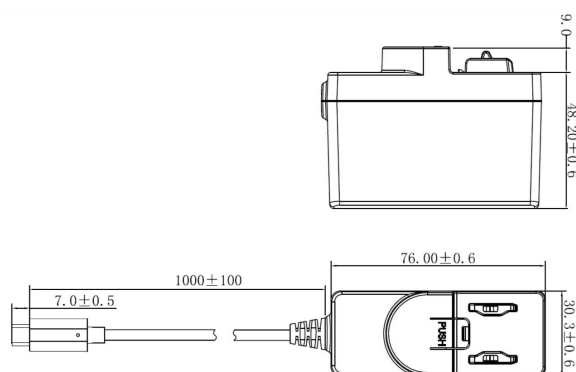

### ■ Specifications

Item	Specification
Model	UES12LCP-050200SPA
Input	100~240V AC input
Output	5V single output,10W
Dimensions	76.0mm (L)×30.3mm (W)×48.2mm(H)
Weight	0.13kg

## 4.3 Workstation (Recommended but not Included)

### ■ Specifications

Item	Requirement
Operating system	Windows 7, 32/64 bits, or higher
CPU	Intel Core I5, or higher
Integration software	iDetector



- To avoid unnecessary troubles during the process of system integration, it is highly recommended to use the workstation configuration certified by iRay Technology.
- Turn off the firewall and anti-virus software to avoid problems such as sensor connection failure or abnormal images.

## 4.4 Router (Recommended but not Included)

Item	Requirement
Frequency range	2.412~2.472GHz: ch1~ch13 5.18~5.24GHz: ch36~ch48 5.745~5.85GHz: ch149~ch165
Recommended router model	TP-LINK: TL-XDR3020 ASUA: RT-AC86U NETGEAR: R7000 Mercury: D121 Teada: AC11

## 4.5 Wireless Communication

Item	Description
Frequency range	2.412~2.472GHz: ch1~ch13 5.18~5.24GHz: ch36~ch48 5.745~5.85GHz: ch149~ch165
Security	WPA-PSK, WPA-WPA2-PSK, WPA2-PSK
Antenna	Built-in dual-band antenna

The Pluto0002XW is equipped with a wireless transmission function, which can generate electromagnetic radiation during the operation of the device, and can also be affected by electromagnetic cross-talk of other electrical equipment in the environment. Its wireless transmission performance is greatly affected by the placement of physical obstacles and materials. During use, attention should be paid to the following aspects:



CAUTION

- Positions the router as high as possible above the sensor
- Reduces the barrier between the sensor and the router
- Chooses channels with fewer devices
- Keeps the sensor and router far away as possible from strong signal interference sources such as motors and transformers

## 4.6 IT Network

Item	Description
Purpose for IT-network	Transmits image data, commands and status commands between sensor and workstation
Intended information flow	The sensor sends the acquired image data to the workstation, and the workstation sends user's instructions to the sensor
Frequency Range	2.412~2.472GHz: ch1~ch13 5.18~5.24GHz: ch36~ch48 5.745~5.85GHz: ch149~ch165
Security	WPA-PSK, WPA-WPA2-PSK, WPA2-PSK



WARNING

- Connection of the sensor to an IT-network that includes other equipment could result in previously unidentified risk that should be identified, analyzed, evaluated, and controlled by the manufacturer of the X-ray machine.
- Subsequent changes to the IT network may introduce new risks that require additional analysis.

Changes to the IT network include:



CAUTION

- Changes in the IT network configuration
- Connection of additional items to the IT-network
- Disconnecting items from the IT-network
- Update of equipment connected to the IT-network

Hazardous situations resulting from the failure of the IT network:



CAUTION

- Failure of completing essential performance
- Failure of finishing configuration of product
- Operating system is not compatible
- Change or update software failed
- Compatibility of interface
- Data transfer protocol error
- Inconsistency of interface or format leads to data distortion
- Data output failed

## Chapter 5 Use

This chapter mainly illustrates how to use the Pluto0002XW system efficiently.

### 5.1 Installing and Removing the AC Plug

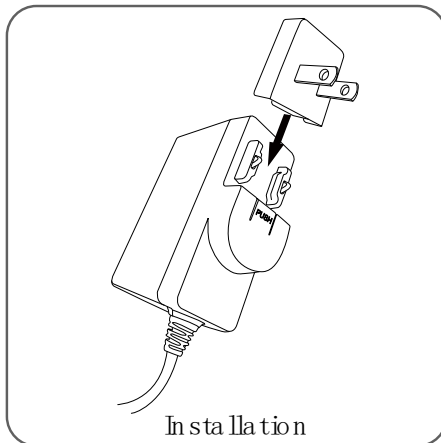

Install the plug by pushing the AC plug along the edge of the adapter connector toward the word “PUSH” until fully locked

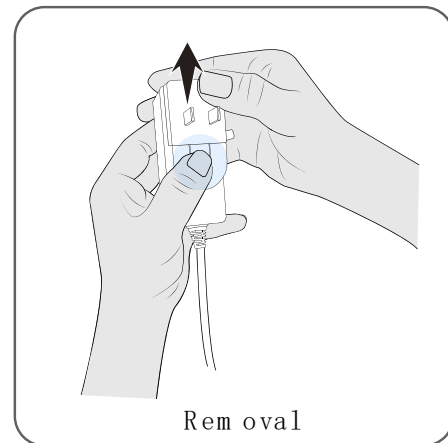

Press the “PUSH” position with the left hand slightly, and push the AC plug in the opposite direction with the right hand until it is completely detached from the connector

### 5.2 Charging the System

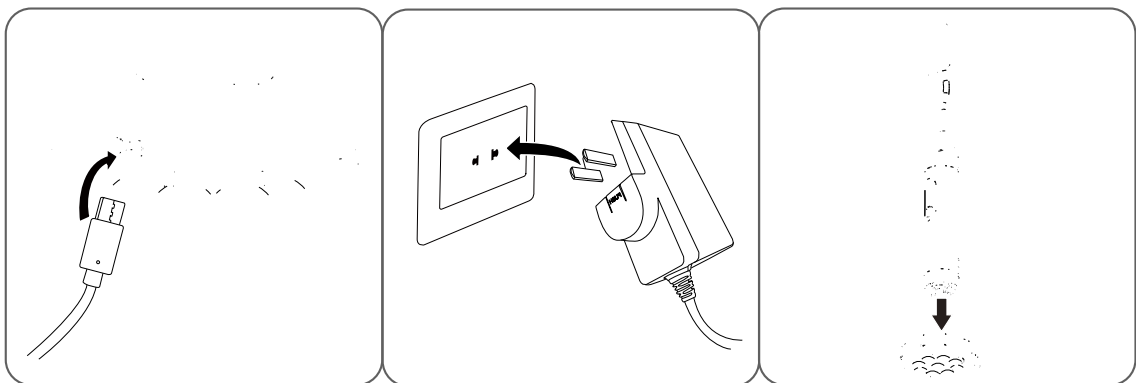

- ① When the battery is low (less than 30%), insert the Type-C interface of the adapter into the charging base;
- ② Plug the adapter into the AC socket;
- ③ Place the sensor close to the charging base in the direction shown, and when the two are close enough, it can be automatically magnetized and connected to charge. When it is fully charged, the power indicator changes from steady blue to off.

## 5.3 Switching ON/OFF the System

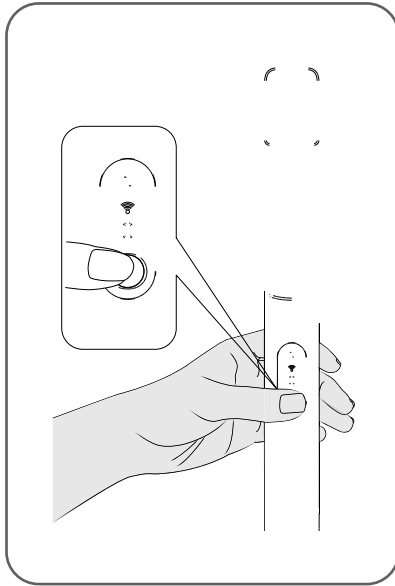

### ■ Startup

When the equipment is off, press the power button for more than 8s to turn it on.

### ■ Powerdown

When the equipment is on, press the power button for more than 8s to turn it off.

## 5.4 Wireless Connection

### 5.4.1 AP Mode

In this mode, the sensor (Pluto0002XW) itself acts as an AP (wireless access point), transmitting wireless hotspots, and the connection between the sensor and the workstation is established via the wireless network transmitted by the sensor AP.



NOTE

It is recommended to configure the sensor using AP mode and acquire images using Client mode because continuous use of AP mode for a long time may accelerate the power consumption and there is a possibility of packet loss

### 5.4.2 Client Mode

In this mode, an external device (such as a router) acts as an AP, and the connection between the sensor (Pluto0002XW) and the workstation (PC) is established via the wireless network transmitted by the external AP.

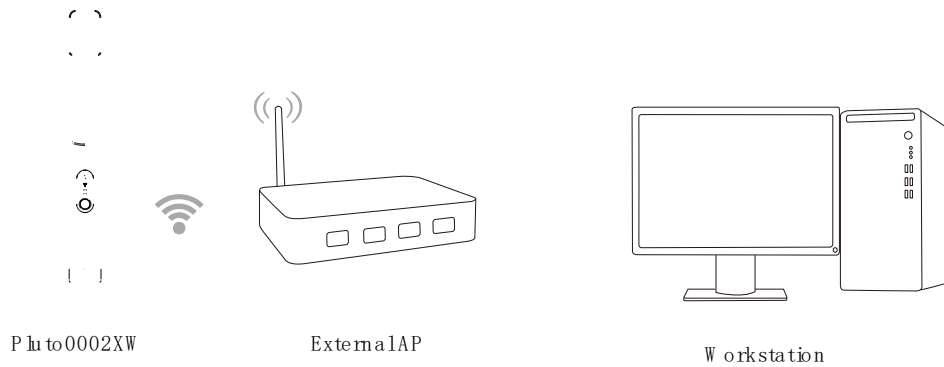

## 5.5 Switching Wireless Mode and Restoring to Factory Settings

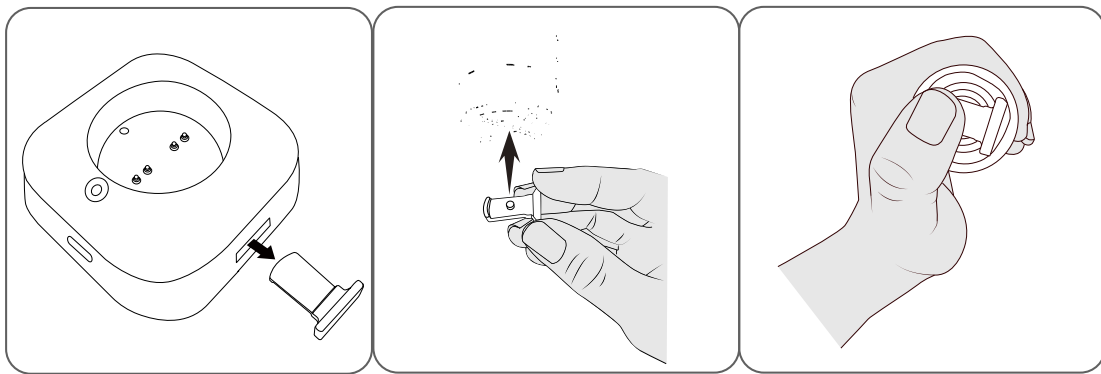

### ■ Mode Switch

- 1) Remove the reset device of the charging base
- 2) Insert the central cylinder boss of the reset device into the central groove of the sensor;
- 3) Press the reset device and hold it for 3s. Remove it after the Link indicator flashes blue, and the mode can be switched successfully

### ■ Network Factory Reset

- 1) Remove the reset device of the charging base
- 2) Insert the central cylinder boss of the reset device into the central groove of the sensor;
- 3) Press the reset device, the Link indicator flashes blue first, then green, and then removes the reset device. The wireless network of the sensor will be restored to the factory state (restores to AP mode, restores the factory default SSID to PlutoXW, password 12345678)



- The default factory wireless connection mode is “AP” mode.
- After each boot, your sensor automatically starts in the wireless mode selected last time.

## 5.6 Installing Disposable Sanitary Sheaths

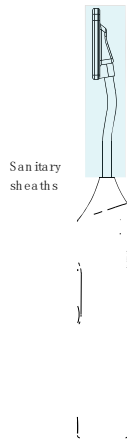

CAUTION

- To help prevent cross-contamination between patients, place a new sanitary sheath on the sensor for each new patient. Please note that the sheath must cover the CMOS sensor and crank area which may have the possibility of contamination.

## 5.7 Device Placement

To place your device properly, refer to the following.

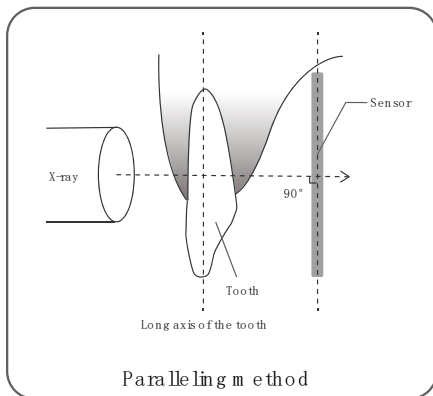

Position the X-ray beam perpendicular to both the CMOS sensor and the long axis of the tooth to be examined

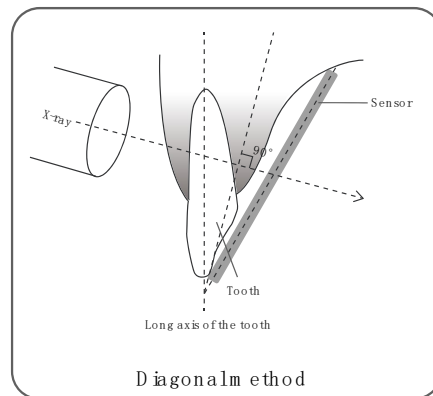

Place the sensor as parallel as possible to the tooth, and direct the X-ray beam perpendicularly towards an imaginary line that bisects the angle between the CMOS sensor and the long axis of the tooth





NOTE

Use of a sensor positioning device is recommended to guarantee that the CMOS sensor is positioned at right angles to the X-ray beam and tooth.

## 5.8 Operating Process

### Preparation

- 1) Place the sensor in the operating environment as described in Section 1.1
- 2) Long press the power button for more than 8s to switch on the equipment
- 3) Check the battery level to make sure it is sufficient (steady orange )
- 4) Configure the wireless communication mode (AP /Client )

### Exposure

- 5) Set the loading factors of the X-ray source (for example, kV, mA, s, etc.)
- 6) Cover the CMOS sensor and crank area with a disposable protective sheath
- 7) Sensor-assisted positioner (not included) is recommended
- 8) Guide the patient to place the CMOS sensor in their mouth correctly
- 9) When preparing to shoot, make sure the sensor allows exposure at this time
- 10) During the shooting, make sure that the patient holds the sensor in a fixed position
- 11) Apply a new sheath for the next patient

### End

- 12) Long press the power button for more than 8s to switch off the equipment
- 13) Clean and disinfect the equipment as described in Section 10.4
- 14) Place the equipment on the charging base

## Chapter 6 Software Installation and Configuration

---

This chapter guides you to install the software operating environment and configure the software.

### 6.1 How to Set up an Operating Environment

#### ■ SDK Decompressing the SDK

Download the SDK from the supplied CD, and decompress it to a location where you plan to install it. SDK contains the operating environment installation files or download path in [... \Tools\env\\_setup](#).

#### ■ Microsoft .NET Framework

Locate the SDK Microsoft folder in [... \Tools\env\\_setup\Microsoft\dotnet\\_setup\\_url](#), select the x86 or x64 driver according to the version of your operating system, and install the driver according to the installation prompts.



Under the XP environment, bind.txt must be placed in an absolute path.

#### ■ Visual C++ Redistributable

To ensure the normal use of Visual C++ applications, find the [Tools\env\\_setup\microsoft\vc redistrib x64 vs2013.exe](#) item in the SDK, and install the VC distribution package `vc redistrib_x86_2013` (or `vc redistrib_x64_vs2013`) as required.

### 6.2 How to Launch the iDetector

iDetector, a basic testing tool, can be run immediately with a double-click without installation, whose SDK path includes:

- 32-bit system, iDetector.exe location: [... \Tools\iDetector\w32](#)
- 64-bit system, iDetector.exe location: [... \Tools\iDetector\x64](#)

### 6.3 Communication Configuration

#### 6.3.1 Configuring the AP Mode



Make sure that the workstation has a wireless card plugged in and the latest version of the wireless card driver installed.

**Configuring the AP Mode**

① Click Start < Control Panel< Network and Internet< Network and Sharing Center< change adapter settings, open the local network connection window, right-click [WLAN], click [Properties], double-click [Internet Protocol Version 4 (TCP/IPv4)], check [Use the following IP address], and enter "192.168.8.188" for the IP address; "255.255.255.0" for subnet mask, click [Confirm] to make it take effect

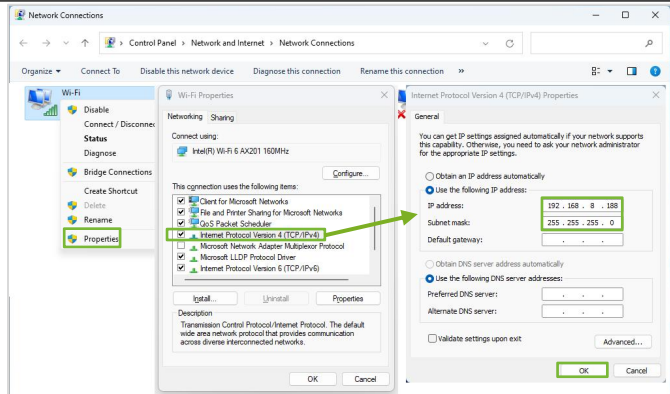

② After the sensor is turned on, wait for the LINK indicator turns steady blue, locate the wireless SSID of the sensor in the workstation wireless network list, enter the SSID and password correctly (the default SSID is PlutoXW, the password is 12345678), click the [Connect] button, and the AP connection is built between the sensor and workstation

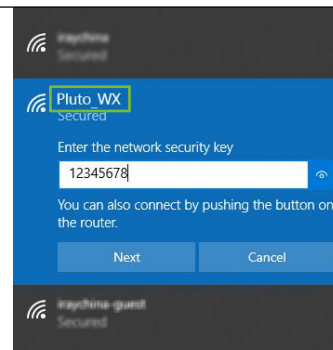

③ To configure this mode, enter the SDK path ...work\_dir\Pluto0002XW\ Correct, double-click the iDetector icon, connect the equipment, switch to the wifi tab, and check the [AP] mode. On this page, you can modify the SSID and Key, sensor IP address (WLAN IP), security level, frequency, country code, band, channel, etc. and click the [Write Network Config] button to save all the changes you have made

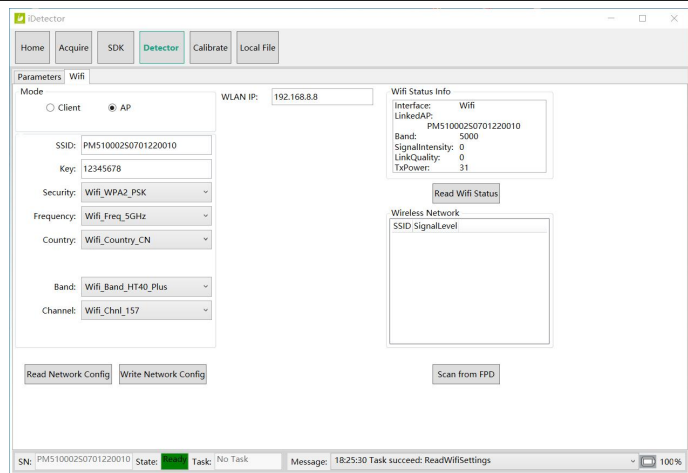

Make sure that the changed SSID is different from the other existing SSIDs.

### 6.3.2 Configuring the Client Mode

#### Configuring the Client Mode

- 1 After the workstation and sensor are successfully connected in AP mode as described in 6.3.1, enter the Wifi tab of the Detector page and check the [Client] mode

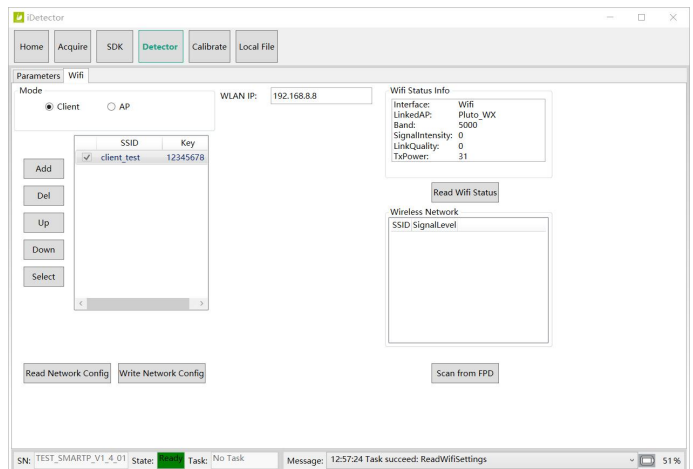

- 2 Click the [Add] button, enter the correct SSID and Key of the external wireless AP (such as router) in the popup window, click the [Apply] button, and then click the [Write Network Config] button to add the wireless network

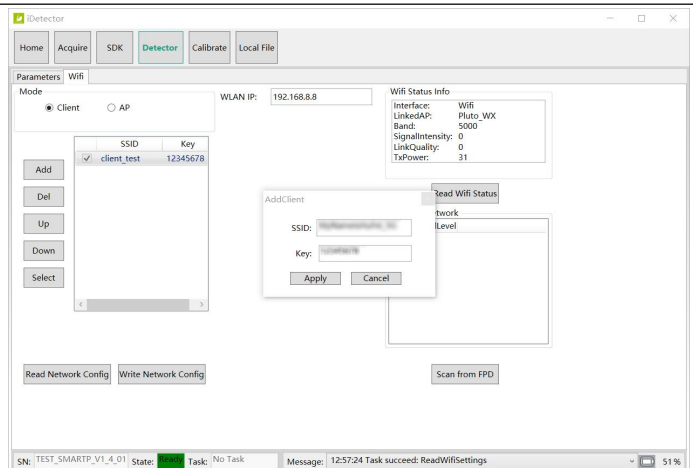

- 3 After adding the wireless network successfully, select the target wireless network in the network list, click the [Select] button (✓ appears right before the selected item), and click the [Write Network Config] button. After the sensor successfully connects to the selected wireless network, the Link indicator turns steady green, indicating it is now in the Client mode

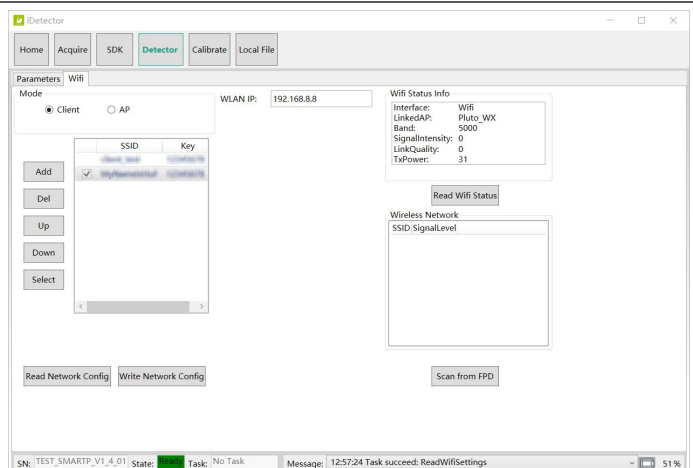

### 6.3.3 Modifying the IP Address

When connecting the sensor for the first time, be sure to set the IP address of your PC wireless network card to the default 192.168.8.188 to ensure a normal connection.

**Modifying the IP Address**

① After the initial connection, if you need to change the sensor IP address to 187.63.0.8 (examples only) and the workstation address to 187.63.0.9 (examples only), you need to go to the Detector >Wifi page, change the detector IP address to 187.63.0.8, and click the [Write Network Config] button

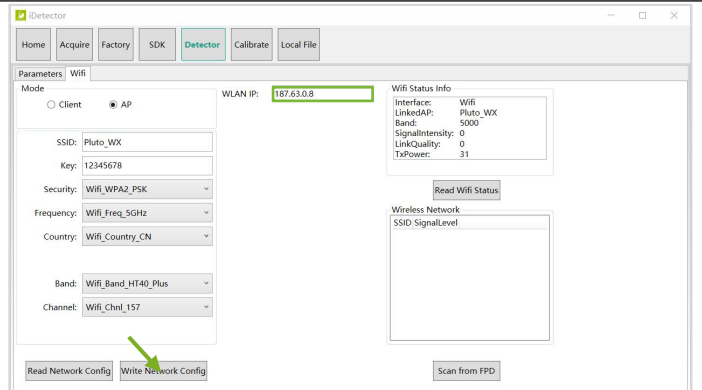

② Go to the SDK page, change the workstation Host IP to 187.63.0.9, and click the [Set] button

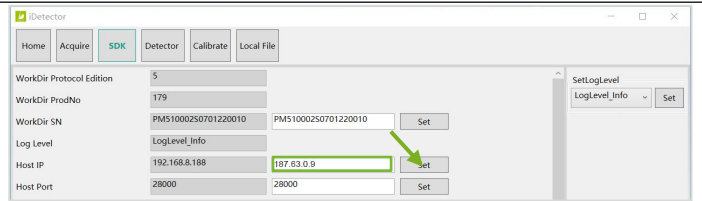

③ Modify the workstation IP address to 187.63.0.9 and click the [OK] button

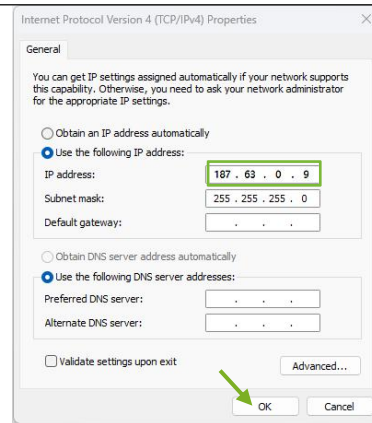

④ Disconnect iDetector, open the config.ini file under SDK path in ...\iDetector\x64\work\_dir\Pluto000 2XW, and confirm if the values of Cfg\_HostIP and Cfg\_RemoteIP are correct

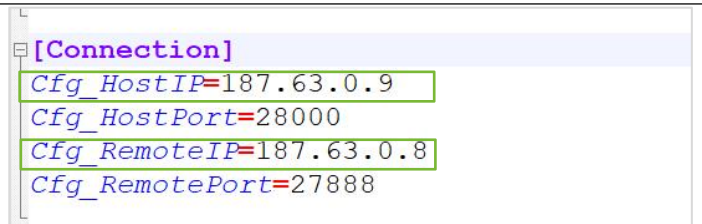

NOTE

To ensure a normal connection, be sure that the IP addresses of the workstation and sensor are on the same network segment.

## Chapter 7 User Interface

This chapter introduces the iDetector user interface and familiarizes you with its functions. The content displayed on the iDetector interface may vary from version to version without prior notice.



REFERENCE

For more details, refer to the following files:

- 903-341-105\_iDetector\_UserManual\_EN\_Ax
- 903-341-103\_SDK\_ProgrammingGuide\_EN\_Ax

### 7.1 Home Page

Double-click the iDetector icon to run the software, and the home page pops up as shown below:

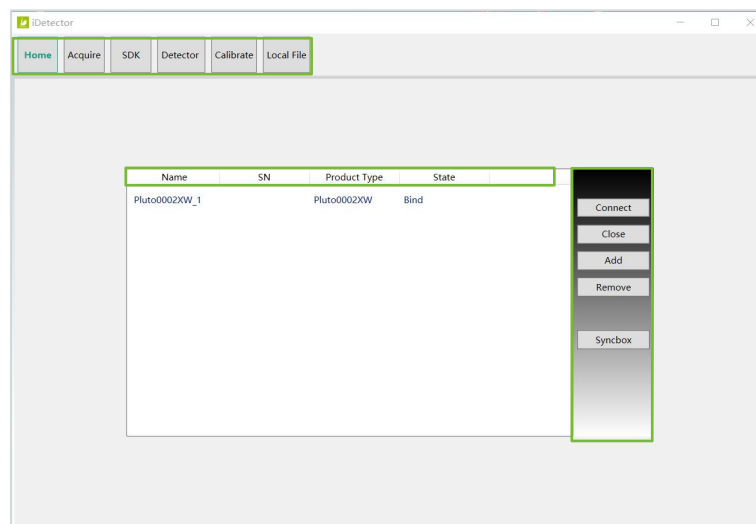

Item	Description	
Tabs	Home	Connects FPD to PC and checks the PC-FPD connection status
	Acquire	Acquires images, selects calibration modes, saves and processes images
	SDK	Configures Config.ini parameters and log level
	Detector	Configures FPD parameters and trigger modes
	Calibrate	Generates and manages calibration files
	Local File	Opens, views local images, and processes images
Information bar	Name	Displays FPD name
	SN	Displays FPD SN
	Product Type	Displays FPD model

Item	Description
	State Displays FPD connection state (bind, unknown, ready, etc.)
	Connect Connects the selected FPD
	Close Disconnects the selected FPD
Buttons	Add Adds a working directory
	Remove Deletes a working directory
	Synabox Open the Synabox configuration window (device optional)



NOTE



Except for the Home page and the Local File page, which can be viewed in offline mode, the other four pages can only be viewed when the sensor is connected.

## 7.2 Acquire Page

Select the corresponding sensor model, and click the [Connect] button on the home page. When the network connection is normal, the sensor will respond to the connection command sent by iDetector. After completing a self-check, iDetector will automatically jump to the Acquire page.

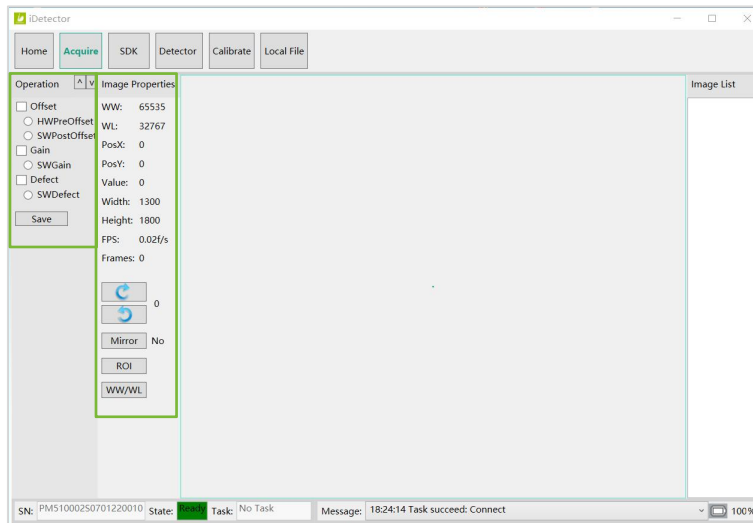
Acquire page, as shown below, allows you to perform operations including image acquisition, calibration method selection, image storage, and processing.



Item	Description		
Template selection	Offset	SWPreOffset	The workstation performs PreOffset calibration
		HWPPreOffset	The sensor performs PreOffset calibration
	Gain	SWGain	The workstation performs Gain calibration
	Defect	SWDefect	The workstation performs Defect calibration
Image properties	WW		Window width
	WL		Window level
	PosX		X coordinate of the current cursor location
	PosY		Y coordinate of the current cursor location
	Value		Gray value of the current cursor location
	Width		Image width
	Height		Image height
	FPS		Acquisition frame rate, keeps the latest frame rate after stopping acquisition
	Frames		Displays the number of frames acquired
			Rotates the image clockwise, 90 degrees every time
			Rotates the image anticlockwise, 90 degrees every time
Mirror		Enables or disables the mirror function of images	
ROI		Checks AVG、SV、SNR and other image parameters of the selected area	
WW/WL		Adjusts WW/WL automatically according to a selection box by performing a right-click	
Image list	Image List		Displays the latest several acquired images, double-click to view image details
	SN		Displays the SN number of the currently-connected sensor
Status bar	State		Indicates the state of sensor, e.g., busy, ready
	Task		Displays the task being executed
	Message		Indicates feedbacks on result of the sensor action, e.g., succeed, failed
	 100%		Displays the current battery percentage

### 7.3 SDK Page

Click [SDK] on the home page to enter the SDK page as shown below, which contains all the parameter information related to the SDK. You can modify some of the modifiable configuration items according to your actual needs.

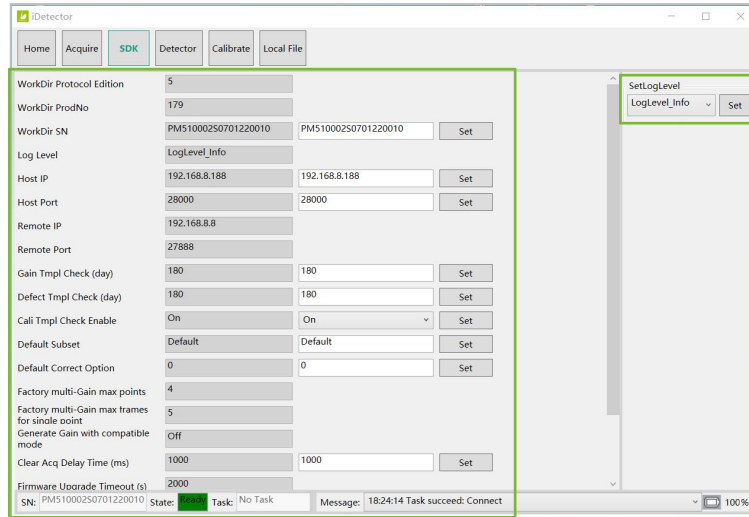

Item	Description			
	Definition	Default	Range	
Configurable parameters	Host IP	PC IP address	192.168.8.188	Any valid IP address
	Host Port	PC port	28000	/
	Gain Tmpl Check (day)	Validity period of Gain template	180	/
	Defect Tmpl Check (day)	Validity period of Defect template	365	/
	Cali Tmpl Check Enable	Detects whether the template is invalid	On	On/Off
	Default subset	Sets the default subset mode	Mode1	-
	Clear Acq Delay Time (ms)	Sets the acquire delay time	1000	-
	Allow SN Mismatch	Allows SN mismatch	Off	On/Off
	Timing output	Enables timed output	Off	On/Off
Retransfer Image Enable	Retransfers the legacy image after restoring the connection	Off	On/Off	
Buttons	Set	Sets the Log level	LogLevel_Info	LogLevel_Debug LogLevel_Info LogLevel_Warn LogLevel_Error LogLevel_Always

## 7.4 Detector Page

Click the [Detector] tab on the Home page to enter the Detector page. On this page, you can view the configuration information of the currently connected sensor, including the SN number, version, and IP address.

### ■ Parameters

When entering the Detector page, you will be directed to the Parameters page by default. The page is mainly divided into three areas: parameter items, operation buttons, and status bar.

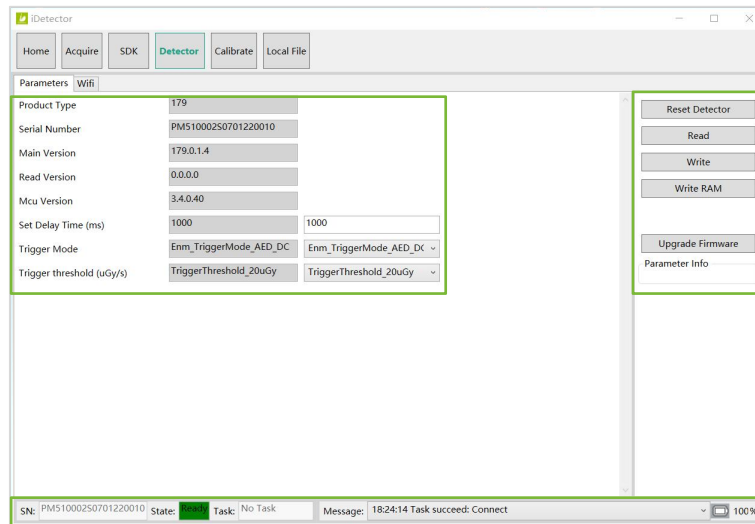

Item	Description		
	Definition	Default	Range
Configurable parameters	Set Delay Time (ms)	Sets the exposure window delay time	1000 /
	Trigger Mode	Sets the trigger mode: Soft (for debugging) AED_DC (for high frequency ray machines) AED_AC (for power frequency ray machines)	AED_DC DC AC
		Trigger threshold (uGy/s)	Sets the AED trigger threshold
Buttons	Reset Detector	Resets the sensor	
	Read	Reads the ROM parameters of the sensor	
	Write	Writes the ROM parameters of the sensor	
	Write RAW	Writes the RAM parameters of the sensor	
	Upgrade Firmware	Upgrades the firmware	

Item	Description		
	Definition	Default	Range
Status bar	Provides feedback on the state of the sensor, and the information of parameters read or written		



WARNING

Before modifying some of the configurable parameters on the Detector and SDK pages, be sure to familiarize yourself with the function and range of each one. Misconfiguring some parameters can cause abnormal operation of the sensor.

## Wifi

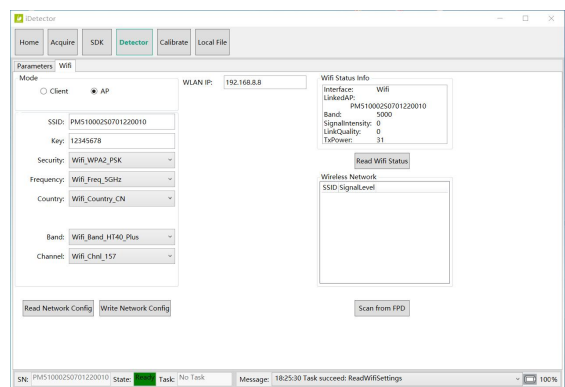
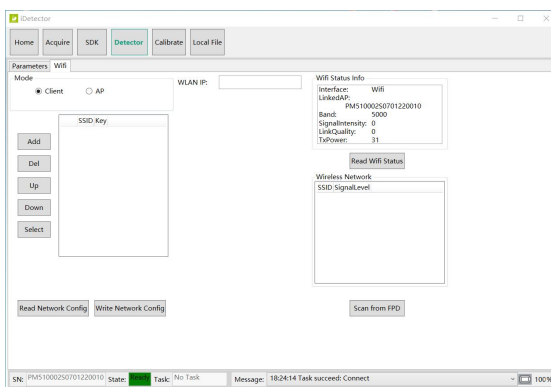

Tab	Item	Description
Client	Add	Adds the SSID and Key of the router
	Del	Deletes the SSID and Key of the router
	Up	Moves up the selected SSID
	Down	Moves down the selected SSID
	Select	Sets the selected SSID as the default connection
	SSID List	Provides 10 sets of external WLAN info (double-click an item to edit information)
AP	SSID	Enters to modify the SSID of the sensor AP
	Key	Enters to modify the Key of the sensor AP
	Security	Selects an encryption mode from the drop-down list box
	Frequency	Selects 2.4GHz or 5GHz frequency band from the drop-down list box
	Country	Selects a country code from the drop-down list box
	Band	Selects a band from the drop-down list box

Tab	Item	Description
	Channels	Selects a channel from the drop-down list box
Client/AP	Read Network config	Reads the sensor's internal wireless configuration parameters
	Write Network config	Resets wireless configuration parameters to the FPD
	WLAN IP	Displays or modifies the sensor IP address
	Read Wifi Status	Reads the wireless connection status of sensor
	Scan from FPD	Scans the list of available SSIDs in the environment

### 7.5 Calibrate Page

Click [Start Generate Template] on the Calibrate page to enter the Create Correct Template page (as shown in the figure below) where you can select an operating mode, and generate and manage calibration templates.

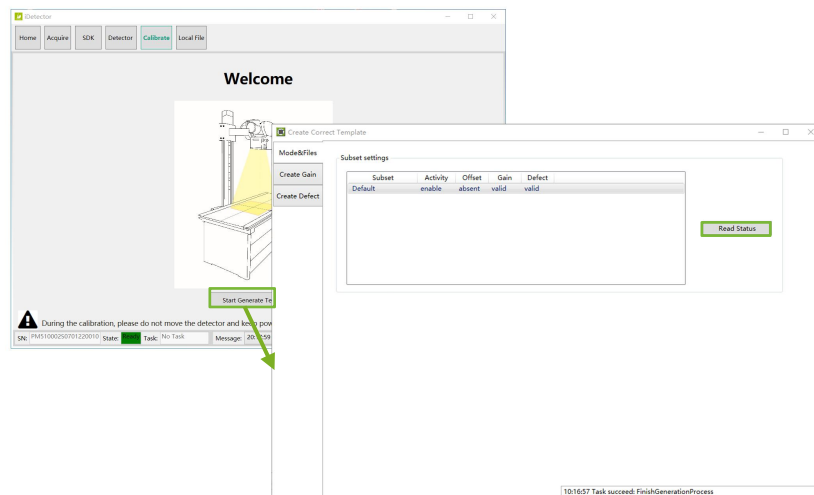

Page	Description
Welcome page	The Create Correct Template page pops up after clicking [Start Generate Templates]
Mode Files	Subset settings      Read Status      Activates the selected template of the left list
Create Gain	Create the Gain calibration template
Create Defect	Create the Defect calibration template

### 7.6 Local File Page

This page allows you to open locally saved images supporting three file formats: .raw, .tiff, and .dcm, and to search for local images.

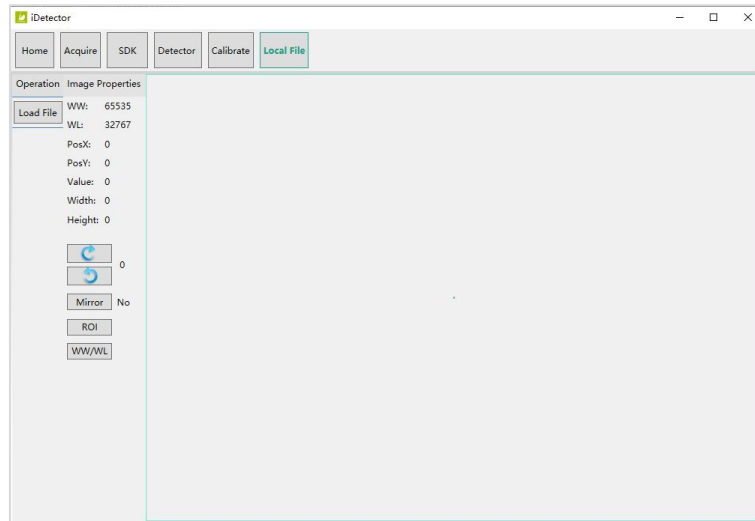

## Chapter 8 Instructions for iDetector

This chapter describes how to operate the software.

### 8.1 Management of Calibration Templates

#### 8.1.1 Creating Calibration Templates

The USB shipped with the sensor contains three calibration files:

File	Path	Description
gain_1300×1800.fac.gn	...\work_dir\Pluto0002XW\Correct	<b>Multi-gain calibration file</b> Without this file, the process of Gain calibration and single-gain template generation will not possibly proceed
gain_1300×1800.gn	...\work_dir\Pluto0002XW\Correct\Default	<b>Single-gain calibration file</b> Without this file, it is required to generate a single-gain calibration template with the help of multi-gain file
defect_1300×1800.dft	...\work_dir\Pluto0002XW\Correct\Default	<b>Defect calibration file</b> Without this file, it is required to generate a defect calibration template

It is recommended to create or recreate calibration templates when:



NOTE

- The sensor is first installed in a DR system
- Changes occur in system settings or hardware configurations
- The voltage value of the X-ray tube is changed
- Every 6 months

#### Creating Gain and Defect Calibration Templates

- ① Copy the multi-gain calibration file (gain\_1300×1800.fac.gn) from the USB to the path `...\work_dir\Pluto0002XW\Correct`

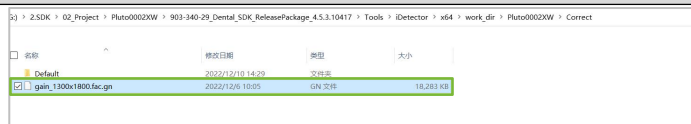

**Creating Gain and Defect Calibration Templates**

- ② Click the [Start Generate Templates] button on the Caliber page to enter the Mode & Files tab, and click [Read Status] button to get the current template file status (absent indicates that the template has not been created; valid indicates the template has been created and is valid; Invalid means that the template exists but is invalid)

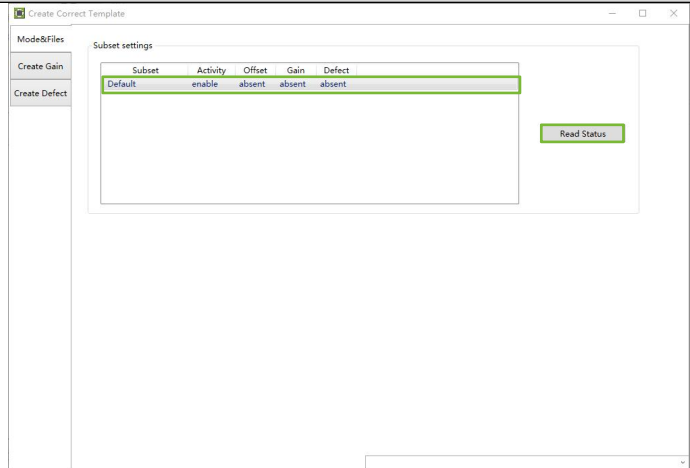

- ③ Switch to the [Create Gain] tab to start the Gain template generation process, click the [Start] button, and the “Initialize to create gain” prompt appears

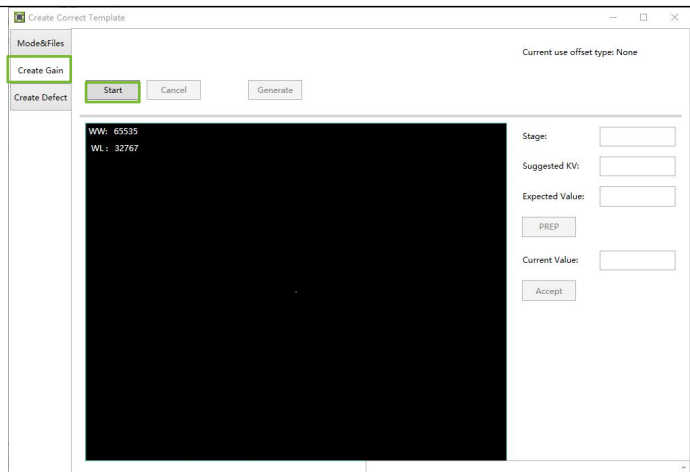

- ④ Adjust the X-ray parameters (exposure time, KV value, etc.) to reach the suggested kV and expected value, align it with the sensor for exposure, the sensor will automatically acquire and upload the image, when the image meets the requirements (the Current Value area is green), click the [Accept] button to accept this image

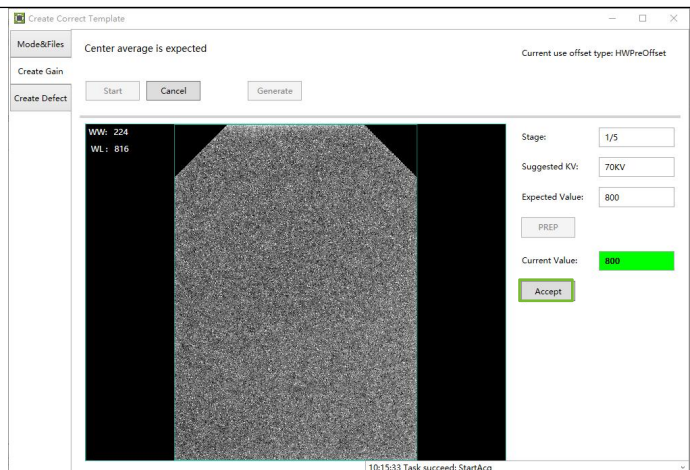

Note: the color rendered in the Current Value area: yellow indicates the image does not meet the requirements but still can generate a template; green indicates the image meets the requirements; red indicates the image does not meet the requirements, the template cannot be generated, and the dose must be modified to reacquire images

**Creating Gain and Defect Calibration Templates**

- ⑤ After the first stage is completed, click the [Generate] button and wait until the prompt “Tasksucceed: Finish Generation Process” appears in the status bar, it indicates that the single-gain template has been created

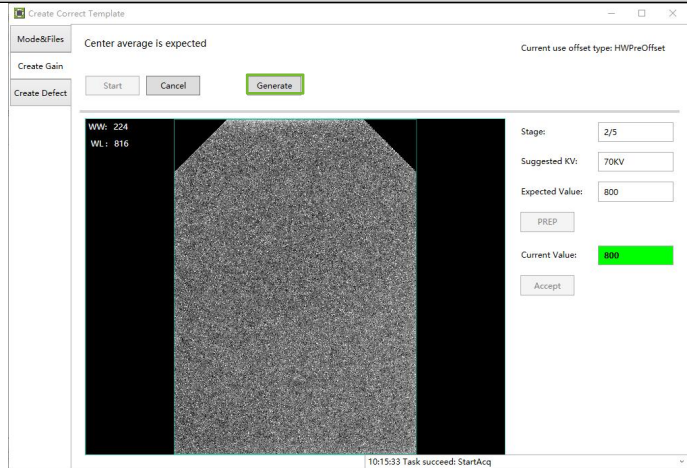

- ⑥ Switch to the [Create Defect] tab to start the Defect template generation process, including 5 stages of image acquisition. Click the [Start] button, the prompt displaying “Initialize to create defect” appears, adjust the parameters of the X-ray source to reach the suggested kV (70kV) and Expected value (4500), the sensor will automatically acquire and upload pictures after receiving X-rays, and click the [Accept] button when green color appears in the Current Value area

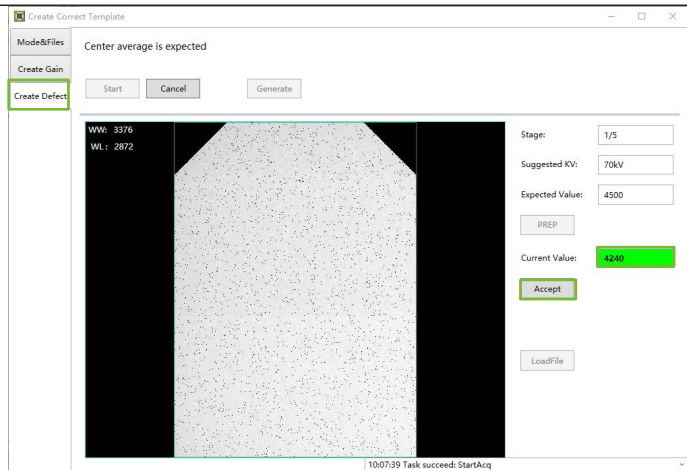

- ⑦ After four more exposures, click the [Generate] button and wait until the “Tasksucceed: Finish Generation Process” prompt appears in the status bar, it indicates that the defect template has been created

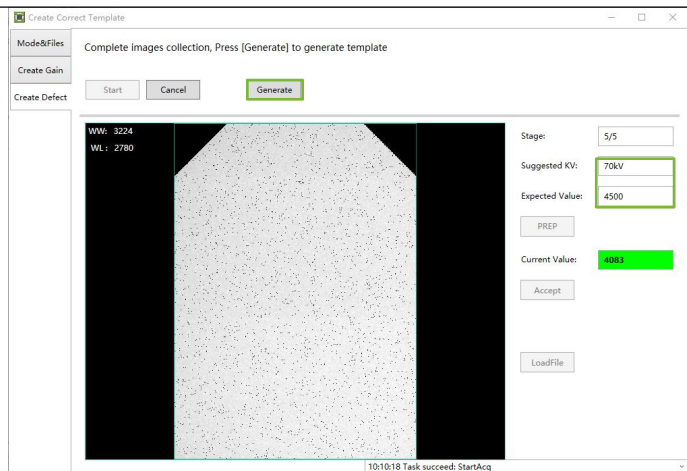

**Creating Gain and Defect Calibration Templates**

⑧ After the Gain and Defect templates are created, switch to the [Mode&Files] tab, click the [Read Status] button, and check whether the Gain and Defect templates exist

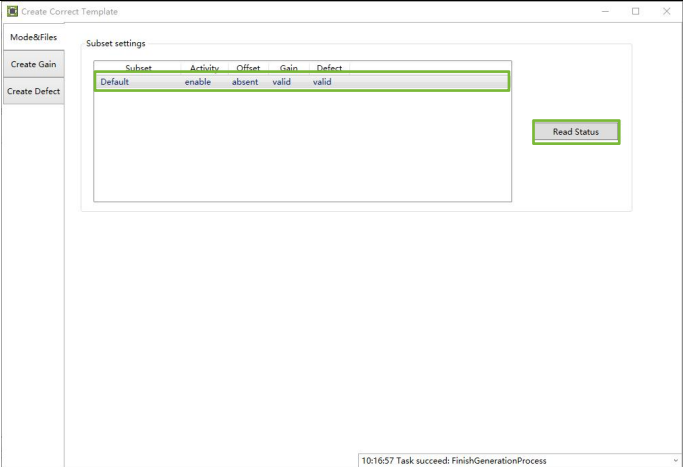

Subset	Activity	Offset	Gain	Defect
Default	enable	absent	valid	valid



A single-gain calibration template can be generated provided that a multi-gain calibration template file (gain\_1300×180 0.fac.gn) exists and is stored in the path ...\work\_dir\ Pluto0002XW\Correct.



Try not to inflict vibration during calibration. In case the sensor is moved, a recalibration is required.

### 8.1.2 Modifying Defect Calibration Template

**Modifying Defect Calibration Template**

① Click the [Local File] button on the local file page

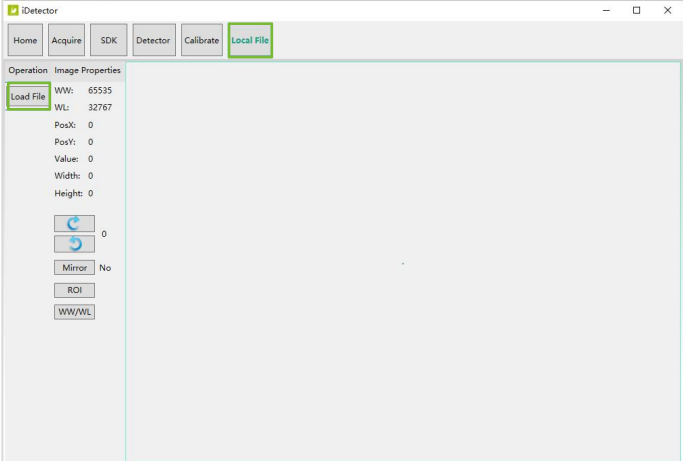

### Modifying Defect Calibration Template

- ② Open a .dft file stored under the path of `...\\Tools\\iDetector\\x64\\work_dir\\Pluto0002XW\\Correct\\Default`, and the Defect calibration template will be displayed in the image view area

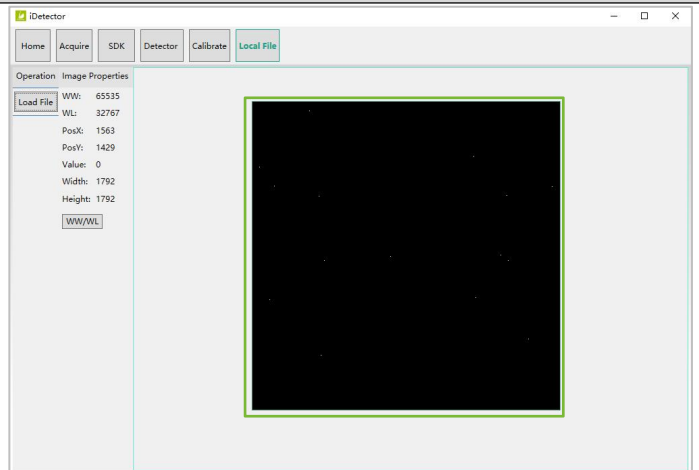

- ③ The defect settings window (DefectMapSetWnd) shown on the right will pop up after the file opens

To edit dead points, zoom in on the defect template, locate a bad point, enter its X&Y coordinates in the point area, click [Add] to add a dead point, and click [Delete] to delete the dead point

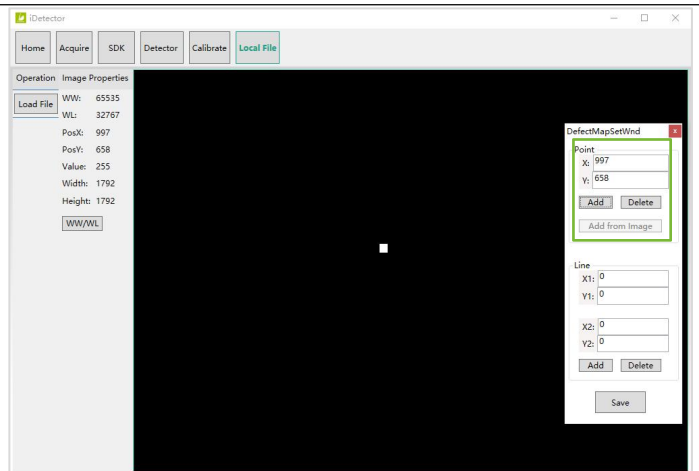

- ④ To edit a bad line: fill in the coordinates of the starting point and end point of the bad line in the Line area, click [Add] or [Delete] to add or delete the bad line, and click [Save] to save the modified Defect template

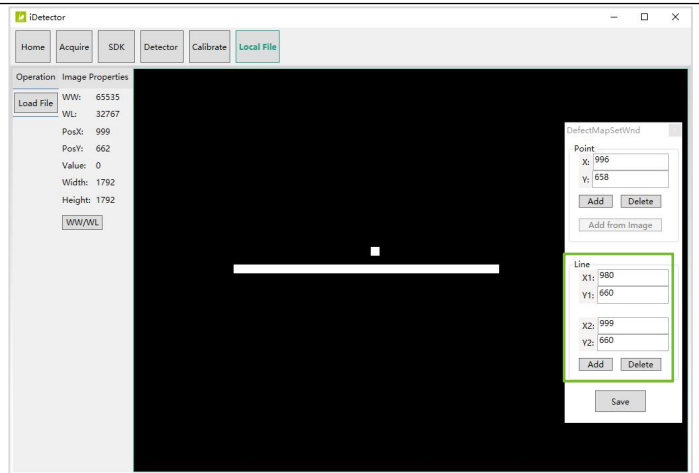

### 8.1.3 Checking the Validity of Calibration Template

When a template is about to reach the set time threshold after a certain period, an alarm will pop up, and the status of the template on the software interface will be changed from “valid” to “invalid” status.

You can check the status of the Template on the Create Correct Template page, Calibrate's subpage.

- “Valid” indicates the selected template exists but is invalid;
- “Invalid” indicates the selected template exists but is invalid;
- “Absent” indicates the selected template has not been created.

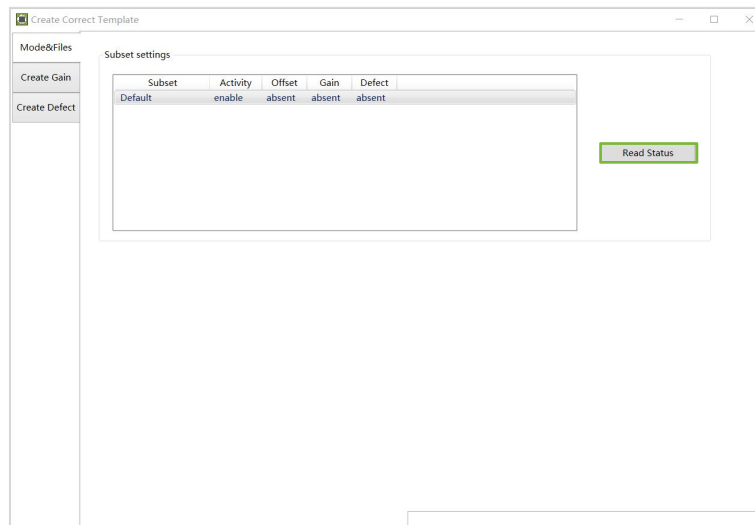

NOTE

- To ensure that the template is in the latest state during each acquisition, it is recommended that you check the validity of the template after it is created and before image acquisition is performed, to avoid image quality degradation due to the absence of templates.
- You can enable/disable the template validity inspection switch by setting the Cfg\_CaliValidity\_Enable parameter in the config.ini file. The value 1 is the enabled state, and 0 is the disabled state.

## 8.2 Acquiring and Saving Image

### 8.2.1 Loading Calibration Templates

Three calibration operations (Offset/Gain/Defect) and two calibration methods (Software/Hardware) are available for Pluto0002XW.



NOTE

- The software method is that the workstation completes all the image calibration processes;
- The hardware method is that the sensor completes all the calibration processes.



NOTE

Before loading the calibration template(s), make sure that the relevant template file(s) exists under the path. ...\\work\_dir\Pluto0002XW\Correct\Default

## ■ Supported Groups of Calibration Options

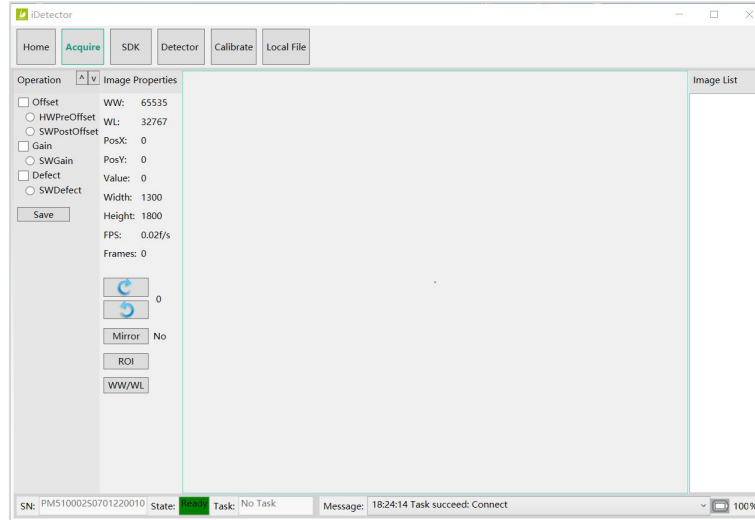

Group	Offset	Gain	Defect	Description
1	HWPreOffset	SWGAIN	SWDefect	Uploads images faster
2	SWPostOffset	SWGAIN	SWDefect	Uploads images slower

Note: Check all three calibration operations of Offset, Gain, and Defect, and the image acquired is fully-calibrated.

### 8.2.2 Saving a Single Image

After loading calibration templates, adjust the X-ray parameters, align the X-ray device to the CMOS sensor, the sensor will automatically acquire and upload the image after detecting the X-rays. You can directly browse to the currently output image in the central image display area on the interface, or browse thumbnails in the Image List area. At this time, the sensor enters a standby state after the image acquisition is completed. To save the image, click the [Save] button and fill in the saved name and path in the pop-up dialog box.

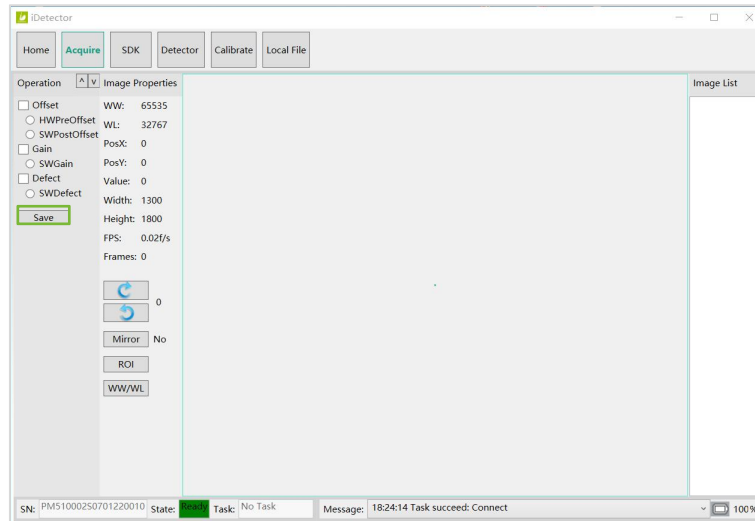

## ■ Imaging Direction

See the corresponding relationship between the sensor and its imaging direction (where ○ is the first-pixel position) in the figure below:

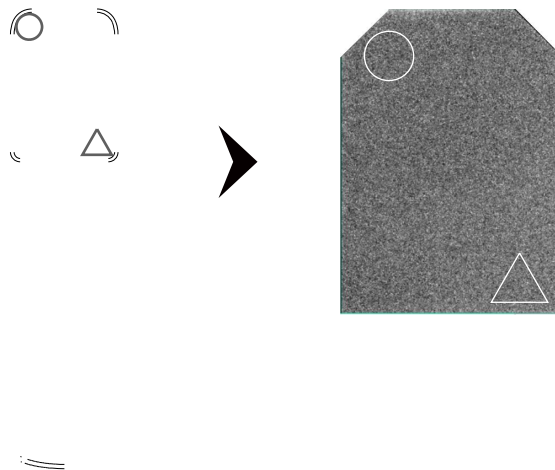

- Ensure that the sensor has sufficient power (>10%) before exposure. Otherwise, the sensor may automatically shut down and the image cannot be acquired.
- Do not inflict vibration during exposure. Otherwise, it may result in poor image quality caused by noise.
- Do not use the equipment near devices generating a strong magnetic field. Otherwise, it may cause image noise, artifacts, or incorrect images.

### 8.3 Checking Local Images

**Checking Local Images**

① Click the [Load File] button on the Local File page to choose and open an image file in .dcm, .dft, .raw, or .tif format from the workstation

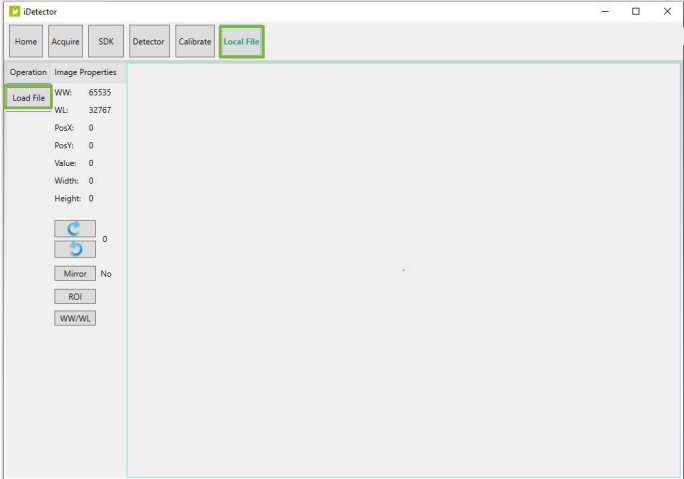

---

② A file in .tiff or .dft format can be opened directly. When selecting a .raw format file, the dialog box as shown on the right will pop up and it can be opened only when the image width and height are input correctly

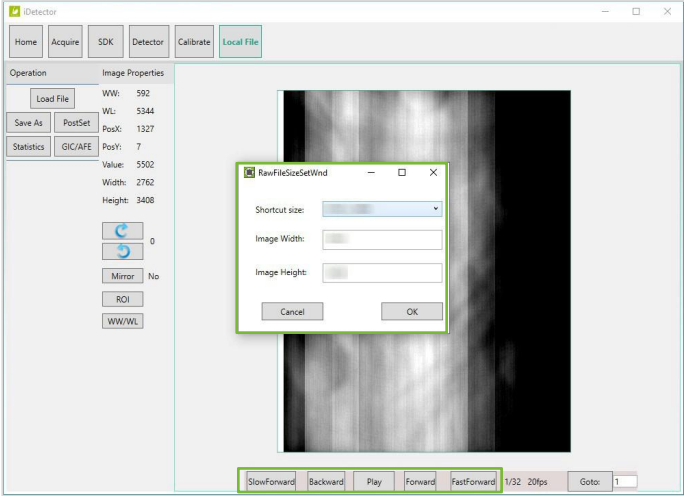

---

③ You can use the ROI tool, right-click to select an image area, and view the AVG, SNR and other properties of the image

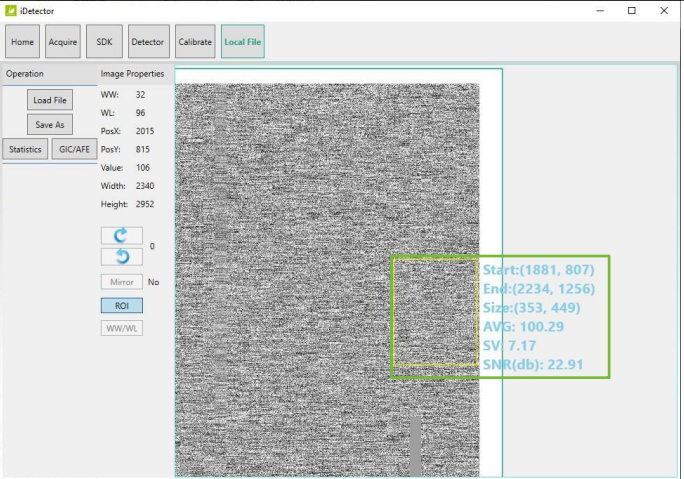



NOTE

- .dcm: image files saved in digital imaging and communication image format.
- tiff: header files, including offset/gain/defect calibration method, real-time frame rate, and exposure window.
- .raw: raw image, headerless file.
- .dft: the image in .dft format can be played like a movie.

## 8.4 Firmware Upgrade



WARNING

For firmware upgrades could cause malfunction to the sensor, do not operate it on your own but with the support of the after-sales technicians of iRay Technology.

### Upgrading Firmware via iDetector

- 1 Enter the [Parameters] tab of the Detector page and click the [Upgrade Firmware] button to enter the Firmware Upgrade page

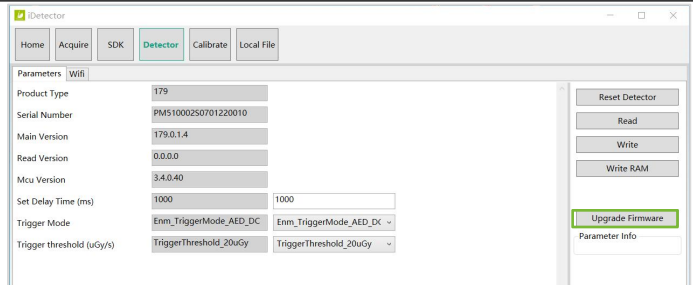

- 2 The Current Version Information area displays the current firmware version. Click [Browse] to select the .ifirm file to be upgraded. After loading the file, the new firmware version will be displayed in the lower information box. Click [Start Upgrade] to start the upgrade. When it is complete, the sensor will automatically restart

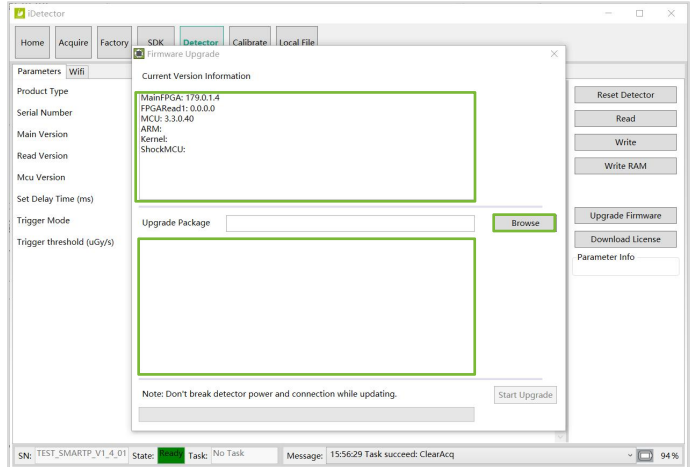

NOTE

After the upgrade is complete, be sure to click the [Upgrade Firmware] button under the Detector page and check whether the firmware version has been updated in the Current Version Information area of firmware upgrade page.

## Chapter 9 Troubleshooting

This chapter illustrates some symptoms that you may face and their possible solutions. If the problems persist even if you perform the solutions listed below, immediately stop operation and contact your local distributor or iRay Technology. Be sure to inform them of the product model, SN, and detailed malfunctions.



NOTE

When a failure occurs in the equipment, you are advised to read the main operation information of the sensor from the log. Either setting `cfg_loglevel` to 0 in the `config.ini` file or changing the `loglevel` to Debug mode on the iDetector SDK interface helps to obtain more detailed command interaction information.

Log path: `...\DetectorDir\detector.log`.

No.	Failure	Cause	Recommended Solution
1	Unable to boot	Low battery power	Connects the charging base to charge the sensor
		Low-power protection designed for equipment	Connects the charging base to charge the sensor
2	Unable to build a wireless connection between the sensor and workstation	Network failure	Reconfigures the external AP or replaces the external AP network
		Incorrect IP address settings	Sets the IP addresses of the sensor and workstation to the same network segment
		Firewall blocking	Turns off the firewall to remove restrictions on the software
		X-rays failed to emit X-rays	Reconfigures the X-ray source until it emits X-rays
		The loading factors are too low to reach the AED minimum trigger threshold	Increases the loading factors (mA, kV, s)
3	No image acquired	The loading factors are too high, exceeding the maximum AED trigger threshold	Reduces the loading factors (mA, kV, s)
		The exposure time is too short and the AED does not detect X-rays	Extends the exposure time appropriately and performs a re-exposure
		The CMOS sensor does not receive rays from the source	Adjusts equipment positioning as described in Section 5.7
4	Blurred image acquired	The patient moved	Prevents patient movement

No.	Failure	Cause	Recommended Solution
		The X-ray source moved	Try to keep the source as still as possible during exposure, and use a tripod when necessary
5	Image acquired too light	The loading factors are too high	Increases the loading factors (mA, kV, s)
6	Image acquired too dark	The loading factors are too low	Reduces the loading factors (mA, kV, s)

## Chapter 10 Service Information

This chapter presents the service information, including service life, a checklist of the periodic inspection and maintenance, as well as the contact information of iRay after-sales service department.

### 10.1 Product Life

The product life is expected to be up to 7 years under proper regular inspection and maintenance.



NOTE

- The whole product life cycle is subject to that of the sensor. The manufacture date of the sensor can be found on the label attached to the equipment, on which the serial number reveals the exact manufacture date of the sensor. See the actual label for details.
- For other replaceable parts, their replacement will not affect the whole product life, even if their service life is shorter than that of the sensor.
- The main parts required to maintain the functioning of this product will be stocked for 5 years after the termination of production to prepare materials for repair.

### 10.2 Regular Inspection

#### 10.2.1 Daily Inspection

To ensure the safe use of the equipment, perform the following checks on the sensor and its accessories every day before and after use.

Stage	Checklist	Operation
Before startup	Operating environment	Check the operating environment to ensure that it meets the requirements described in Section 1.1 and that the temperature difference between the device and the room does not form condensation
	Sensor	Check if the sensor is damaged
		Check if the sensor is clean and dry and if it is covered with a disposable protective sheath
		Check if the battery power is sufficient (greater than 30%)
Accessories	Check if accessories are damaged and cable housing is torn	
After startup	Patient	Check whether the patient is wearing a radiation protection device
	Equipment positioning	Check that the relative position of the equipment, X-ray source, and tooth meets the requirements described in Section 5.7

Stage	Checklist	Operation
After shutdown	LEDs	Check whether the equipment is powered off normally and all LED indicators are off
	Sensor	Check if the CMOS sensor and crank surfaces are clean and disinfected

### 10.2.2 Monthly or Yearly Inspection

To ensure good performance and reliability of your equipment, perform the following checks monthly/annually:

Checklist	Frequency	Operation
Battery	Monthly	Checks the battery performance to see if it loses power quickly in a short period
Bad points Dark state noise Image uniformity	Yearly	Uses system checker
Resolution	Yearly	Detects by resolution map or using the resolution test card
Linear	Yearly	Examines the image gray value to evaluate linear



Only qualified and authorized service personnel is allowed to remove the covers on the equipment.

### 10.3 Maintenance

The Pluto0002XW does not require any special maintenance other than regular cleaning and disinfection.

## 10.4 Cleaning and Disinfection

After the equipment is used, perform the following steps to clean and disinfect it:

- ① Put on single-use PPE gloves;
- ② Open the package lid, pull out a wipe through an opening, and close the lid to retain moisture;
- ③ Remove the disposable protective sheath, if there are obvious stains on the sensor, wipe it clean before disinfection;
- ④ Wipe the CMOS sensor and the handle of the sensor from top to bottom to disinfect them;
- ⑤ After cleaning, dispose of the used wipes, gloves, and sheaths into the medical waste bin;
- ⑥ Let the surface air dry.

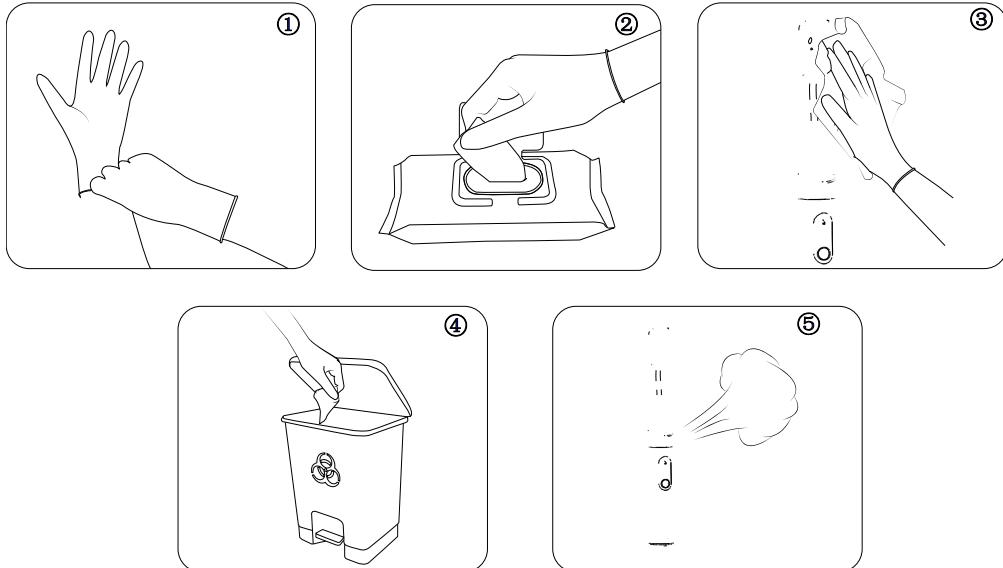

- **Recommended commercial brands of wipes:**

Alcohol-Quat solution: PDI Super Sani-Cloth® Germicidal Disposable Wipes;

Alcohol-Chloride solution: Clinell® Universal Wipes

- **If the two wipes above are not readily available in your area, you can make up your solvent based on the ingredient concentrations below.**



NOTE

**Alcohol-Quat solution**

- 0.25% n-Alkyl dimethyl ethylbenzyl ammonium chlorides
- 0.25% n-Alkyl dimethyl benzyl ammonium chlorides
- 55.00% Isopropyl Alcohol

**Alcohol-Chloride solution**

- ≤0.5% Benzalkonium chloride
- ≤0.5% Didecyl dimethyl ammonium chloride
- ≤0.10% Polyhexamethylene biguanide (PHMB)



- The equipment should be cleaned and disinfected before its first use, whenever the equipment is contaminated, and at the end of each day even when the sheaths are used.
- Prior to cleaning, ensure that the equipment is powered off and removed from the charging base.
- Do not spray the sensor directly with detergent, or immerse it in liquids.
- Never use flammable cleaning detergent such as alcohol, ether, and corrosive liquids such as methanol, benzene, acids, and bases to clean equipment.

## 10.5 After-Sales Service

CS Dept.:	After-Sales Service Department of iRay Technology Co., Ltd.
Address:	Building 45, No. 1000, Jinhai RD., Pudong New Area, 201206 Shanghai China
Tel:	+86-21-50720560
Fax:	+86-4008266163-60610
Email:	service@iraygroup.com
Website:	www.iraygroup.com